

**MİMARİ KATALOG**  
**ARCHITECTURAL CATALOGUE**

**Alüminyum Kapı Pencere ve Giydirme Cephe Sistemleri**  
Aluminium Window Doors and Facade Systems

**RESCARA**



**COMP 50**

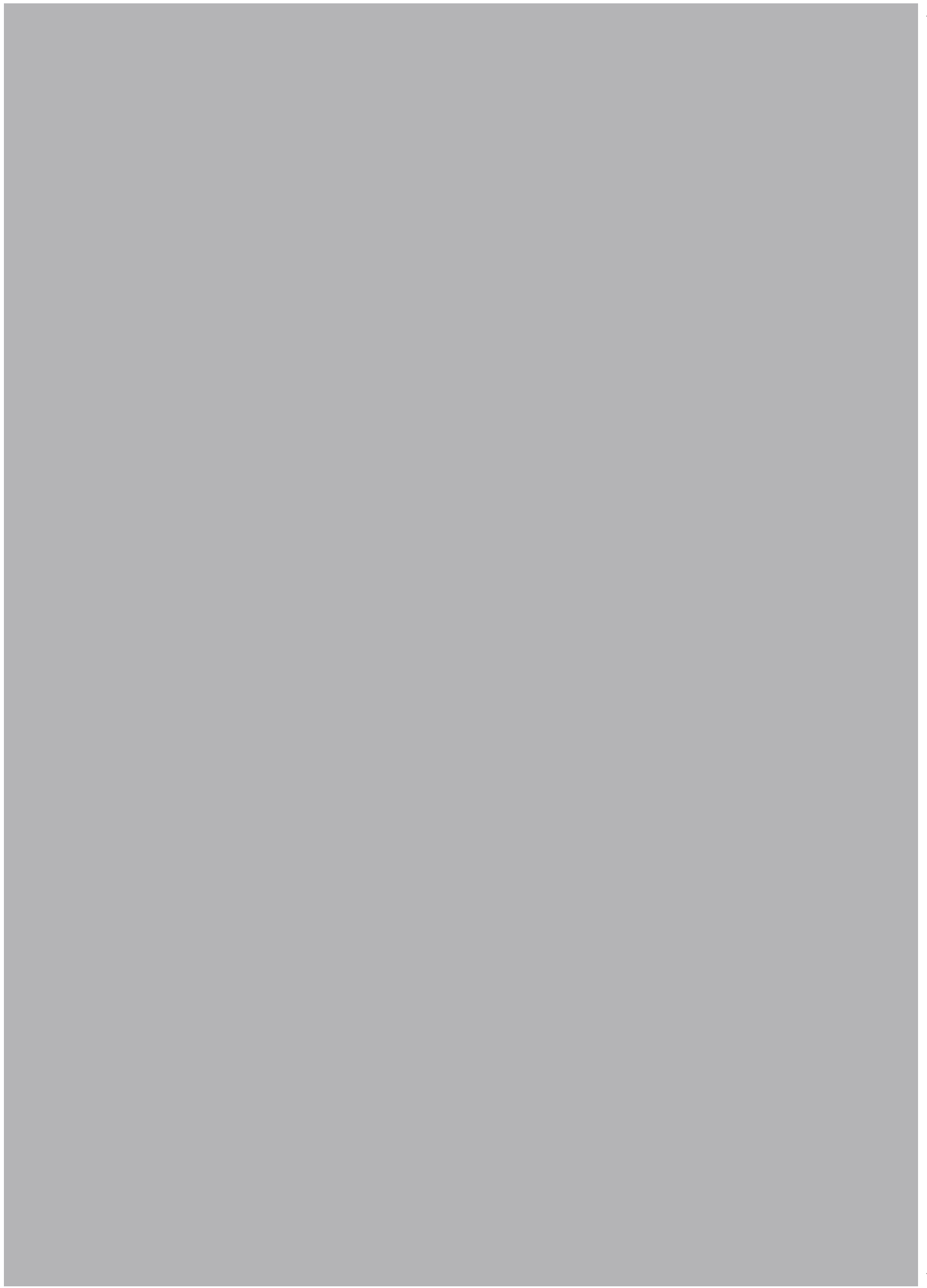

# MİMARİ KATALOG ARCHITECTURAL CATALOGUE

Alüminyum Kapı Pencere ve Giydirme Cephe Sistemleri  
Aluminium Window Doors and Facade Systems



Rescara Sistem Detayları  
Rescara System Details

# COMP 50

PROFİLLER

PROFILES

01

02

03

04

05

06

07

08

09

10

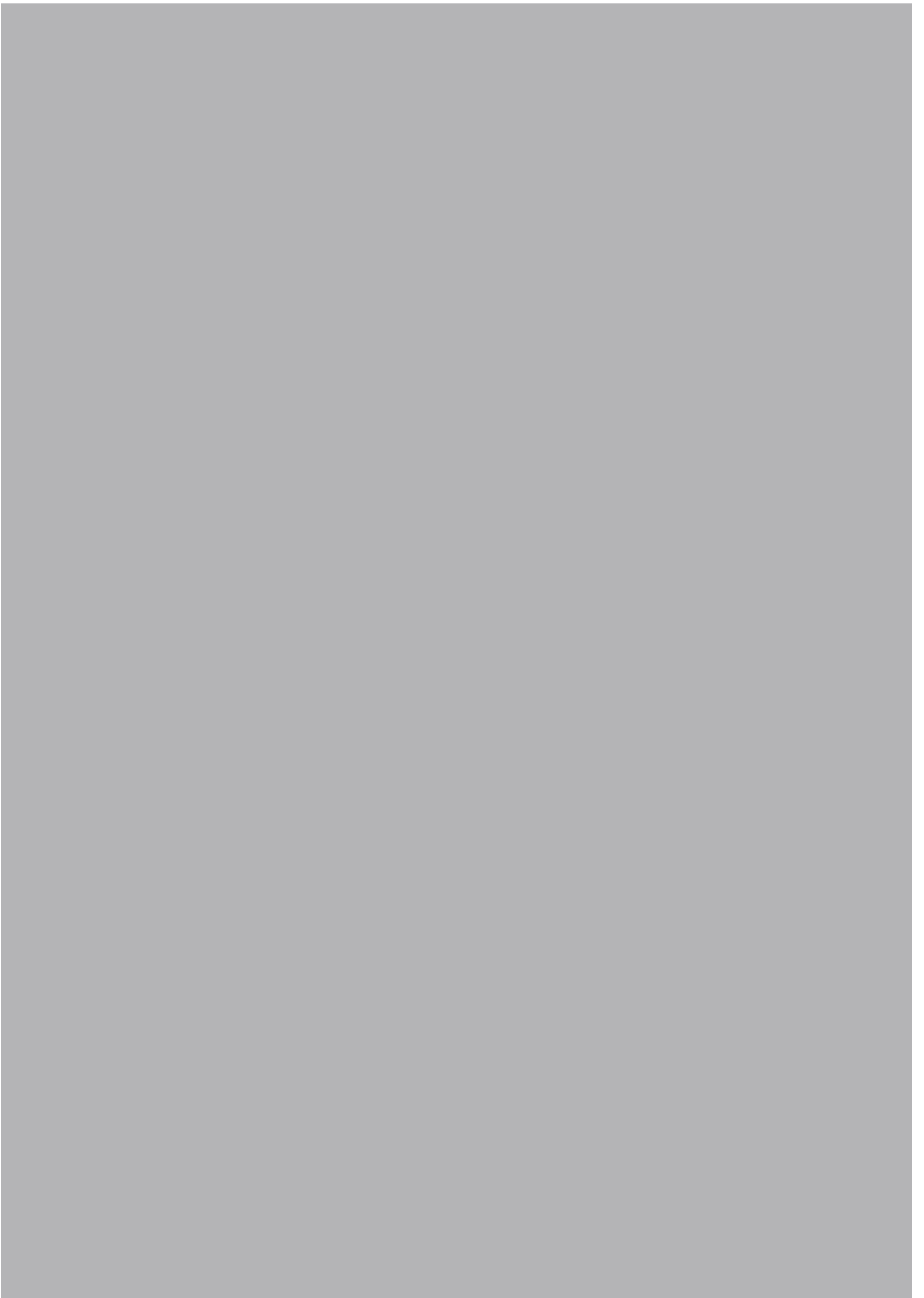

DÜŞEY PROFİLLER  
MULLION PROFILES

# COMP 50

KOD / CODE	AĞIRLIK (kg/m) / WEIGHT	Jxx cm <sup>4</sup>	Jyy cm <sup>4</sup>	L m	
A010634	1,271	10,261	24,261	6	
A011039	1,447	27,917	28,126	6	

A010634

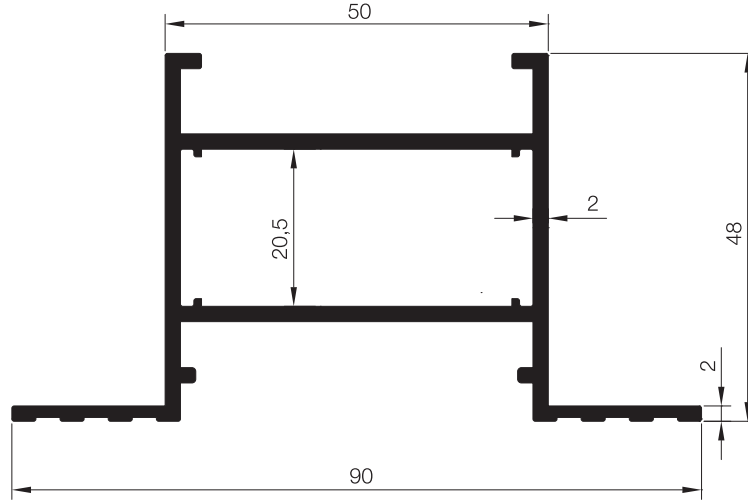

A011039

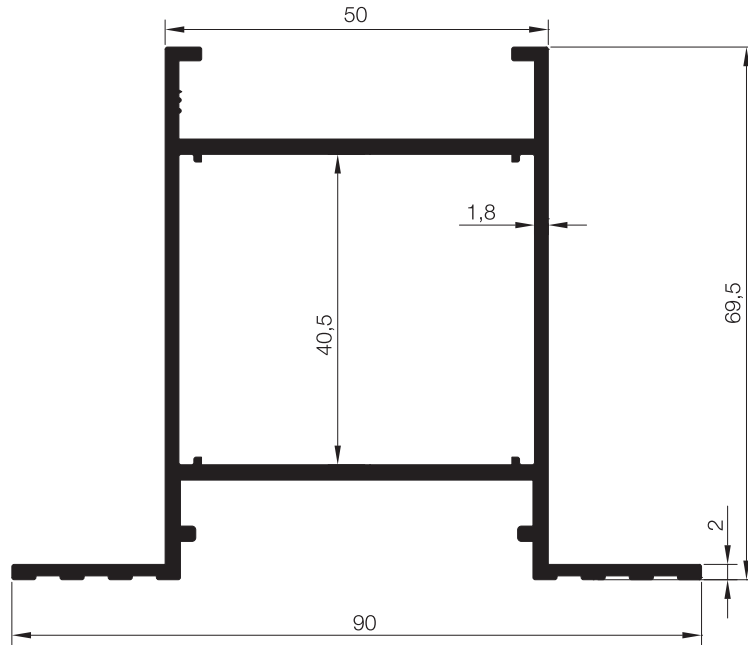

01

02

03

04

05

06

07

08

09

10

ADAPTÖR PROFİLLERİ  
ADAPTER PROFILES

# COMP50

KOD / CODE	AĞIRLIK (kg/m) / WEIGHT	L m	KOD / CODE	AĞIRLIK (kg/m) / WEIGHT	L m
A006531	0,368	6	A003561	0,199	6
A001100	0,224	6	A011191	0,295	6
A003558	0,238	6	A011484	0,168	6
A006773	0,222	6	A011485	0,335	6
A000257	0,335	6			

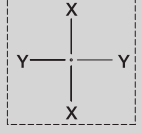

01

02

03

04

05

06

07

08

09

10

A006531

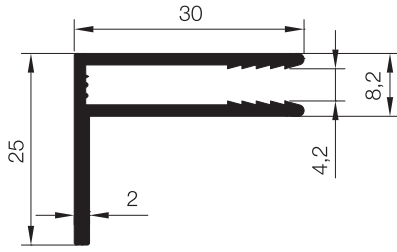

A001100

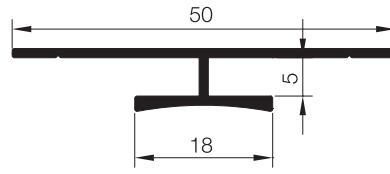

A003558\*

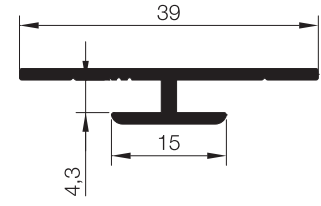

A006773

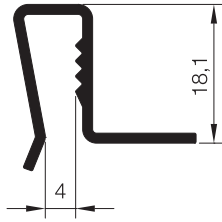

A000257

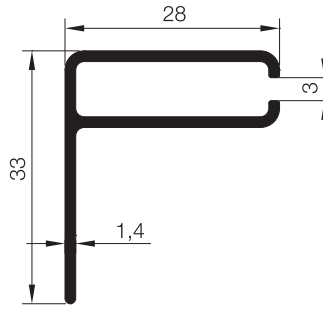

A003561

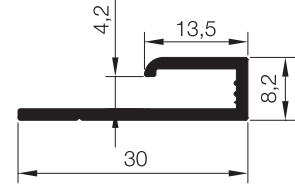

A011191

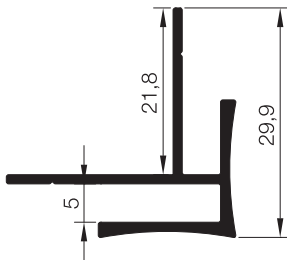

A011484

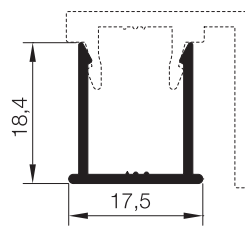

A011485

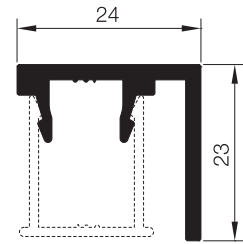

STOKTA BULUNAN SİSTEM PROFİLLERİNİN LİSTESİ (LIST OF SYSTEM PROFILES IN STOCK)

Nr	MIN. SİPARİŞ MİKTARI MIN. ORDER QUANTITY
A003558	75 kg

\* STOKTA BULUNMAYAN TÜM PROFİLLER İÇİN MİNİMUM SİPARİŞ MİKTARI 300'KG'DİR.  
MINIMUM ORDER QUANTITY FOR ALL THE PROFILES THAT ARE NOT IN STOCK IS 300 KG.

MİMARİ KATALOG  
ARCHITECTURAL CATALOGUE

Alüminyum Kapı Pencere ve Giydirme Cephe Sistemleri  
Aluminium Window Doors and Facade Systems



Rescara Sistem Detayları  
Rescara System Details

# COMP 50

DETAYLAR

DETAILS

01

02

03

04

05

06

07

08

09

10

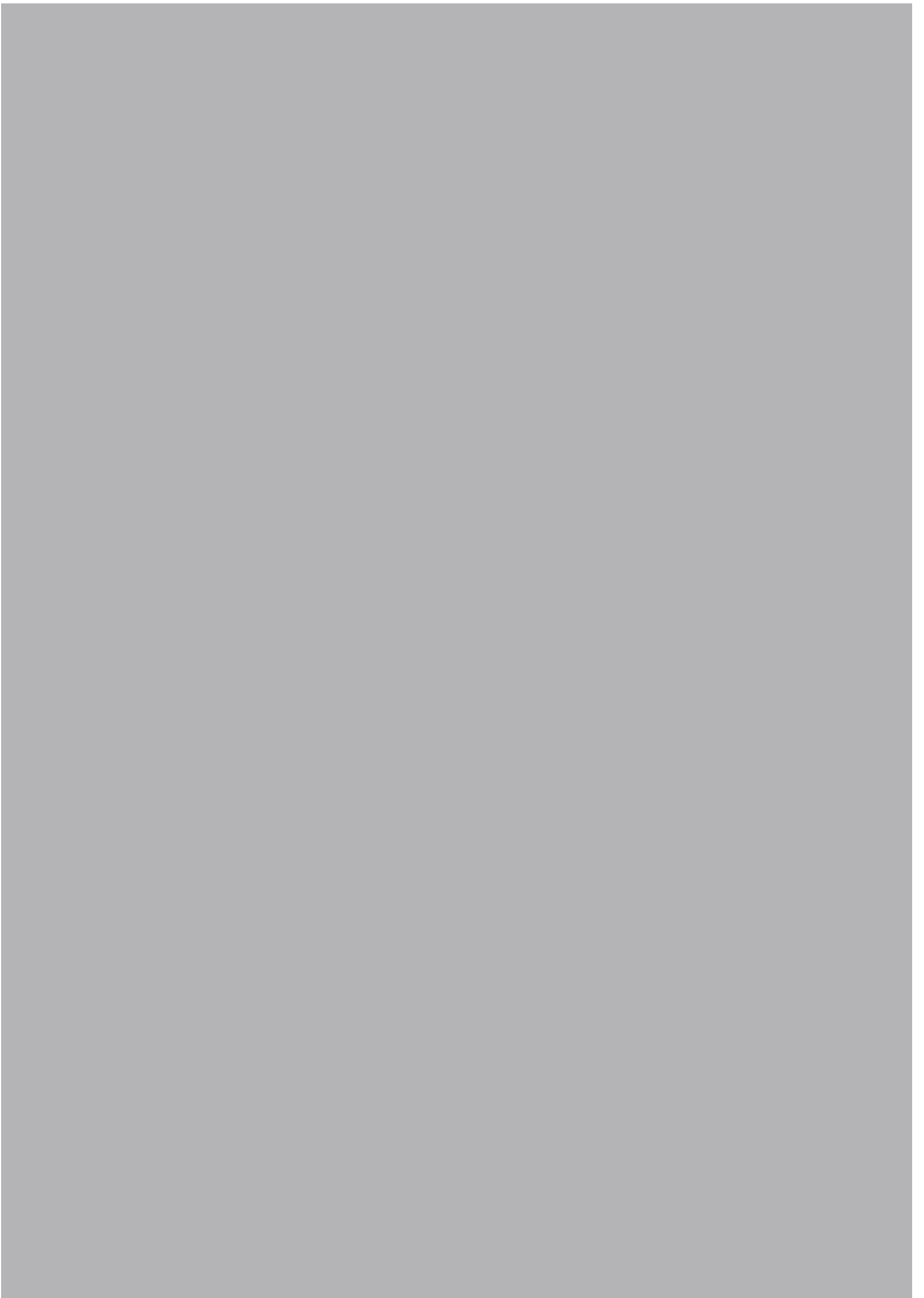



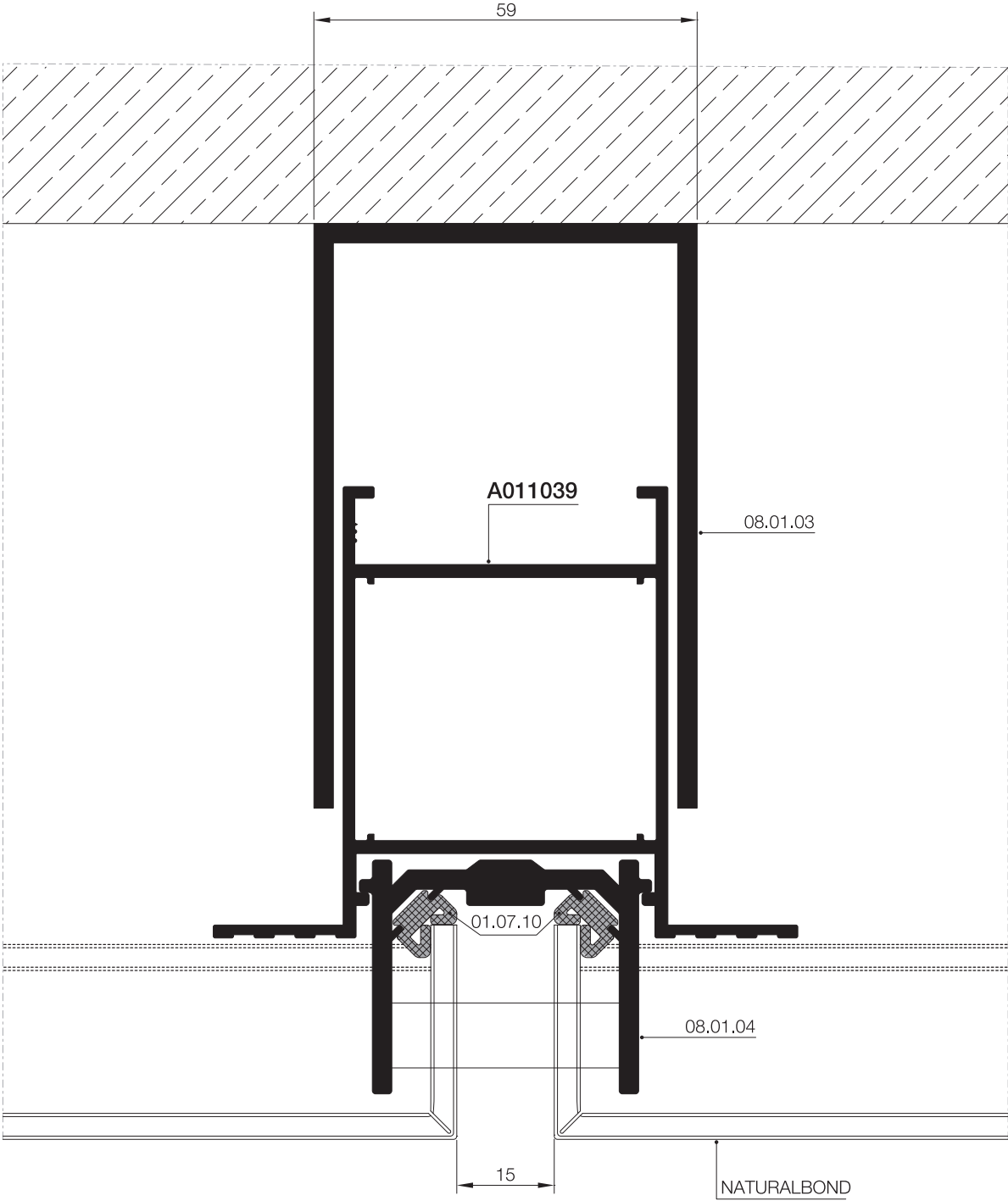

- 01
- 02
- 03
- 04
- 05
- 06
- 07
- 08
- 09
- 10

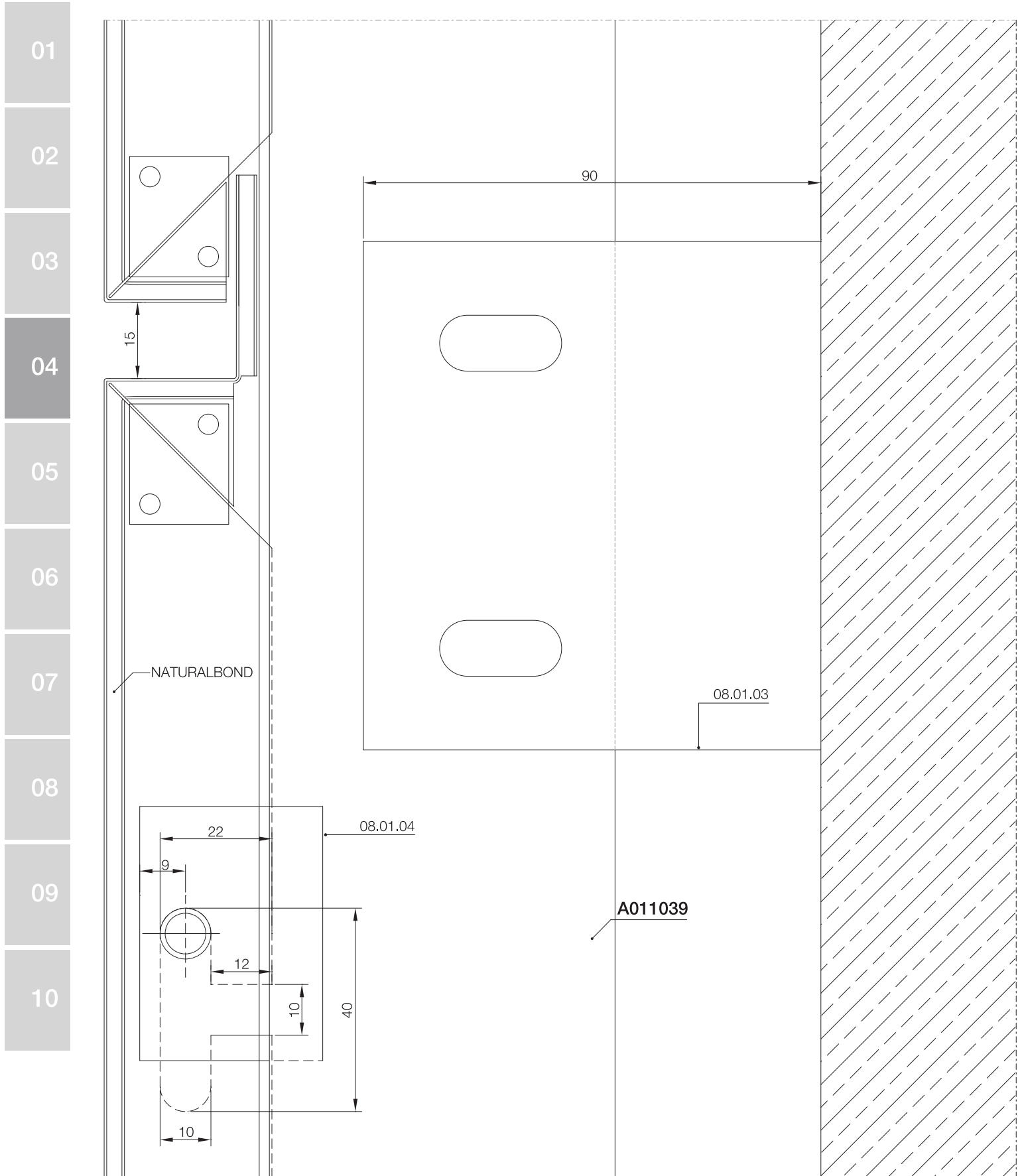

# MİMARİ KATALOG ARCHITECTURAL CATALOGUE

Alüminyum Kapı Pencere ve Giydirme Cephe Sistemleri  
Aluminium Window Doors and Facade Systems



Rescara Sistem Detayları  
Rescara System Details

# COMP 50

AKSESUARLAR

ACCESSORIES

01

02

03

04

05

06



07

08

09

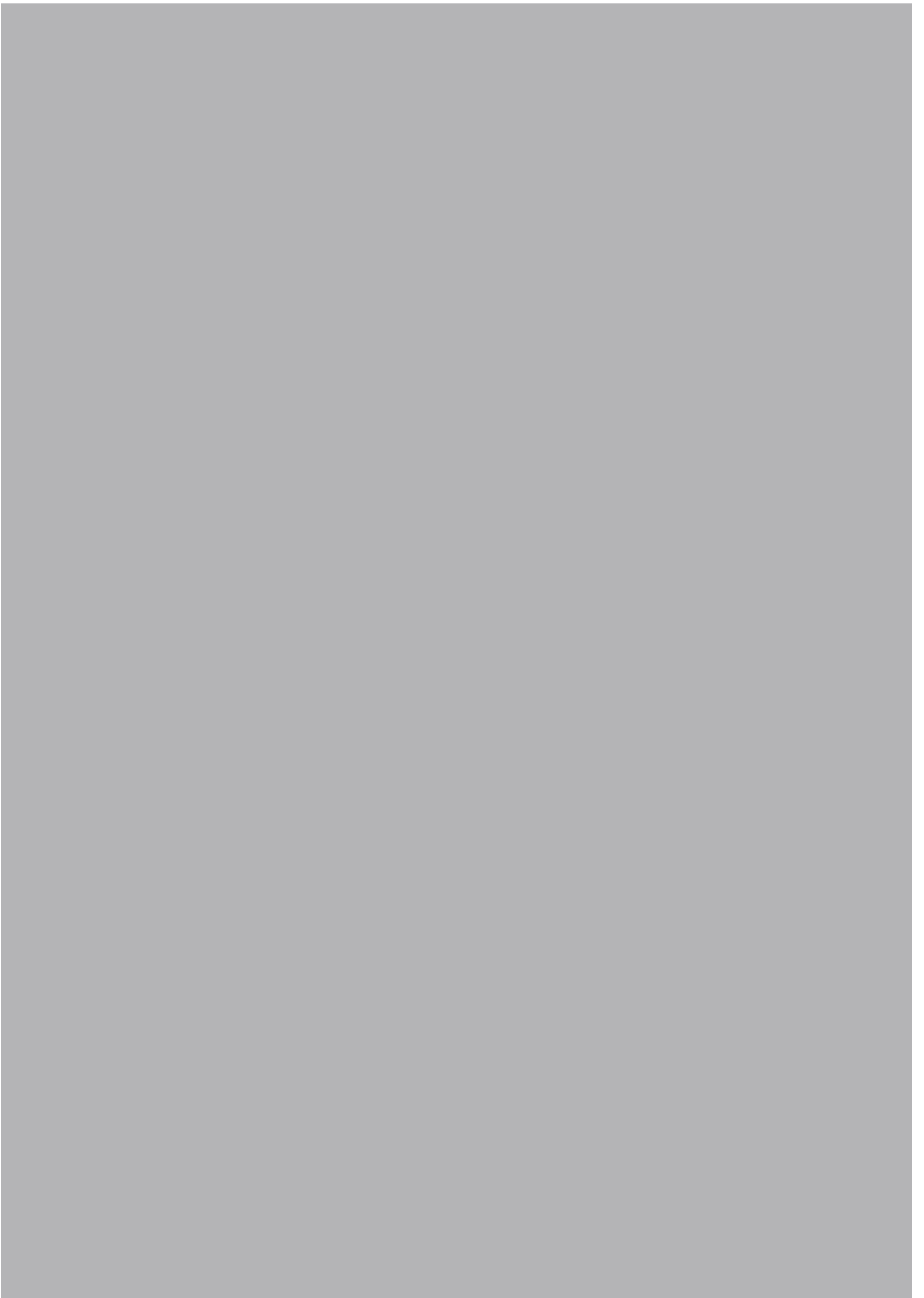
10

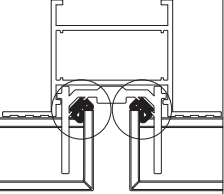

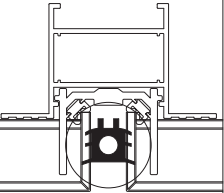
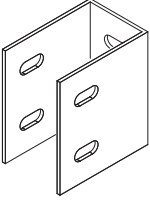
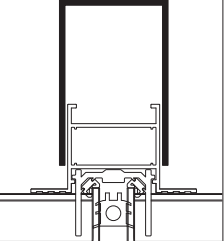
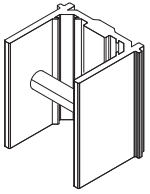
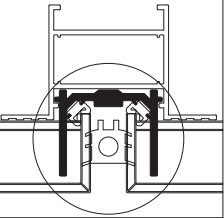
	<b>01.07.10</b> FİTİL GASKET  Malzeme / Material : EPDM Ağırlık / Weight : 72 gr/m Paket / Package : 208,3 m / 15 kg				
	<b>01.07.14</b> DERZ FİTİLİ LINE GASKET  Malzeme / Material : EPDM Ağırlık / Weight : 225 gr/m Paket / Package : 65 m / 15 kg				
	<b>08.01.03</b> ALÜMİNYUM ANKRAJ ANCHORAGE (ALUMINIUM)  Profil No A010635 (1,895 kg/m) Profil No A010635 (1,895 kg/m)				
	<b>08.01.04</b> ANAHTAR GEÇME BAĞLANTI CONNECTION PIECE  Profil No A010633 (1,056 kg/m) Profil No A010633 (1,056 kg/m)				

01

02

03

04

05

06

07

08

09

10

