

C 50

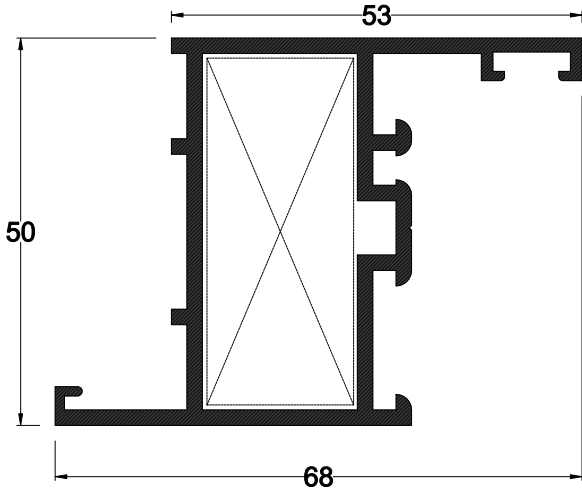

99-1037

AĞIRLIK : 1.220 kg/mt.
JX: 15.87 cm⁴
JY: 10.78 cm⁴

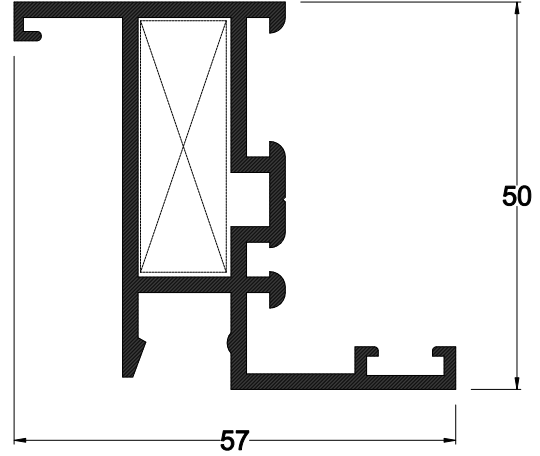

99-1042

AĞIRLIK : 1.080 kg/mt.
JX: 12.22 cm⁴
JY: 5.90 cm⁴

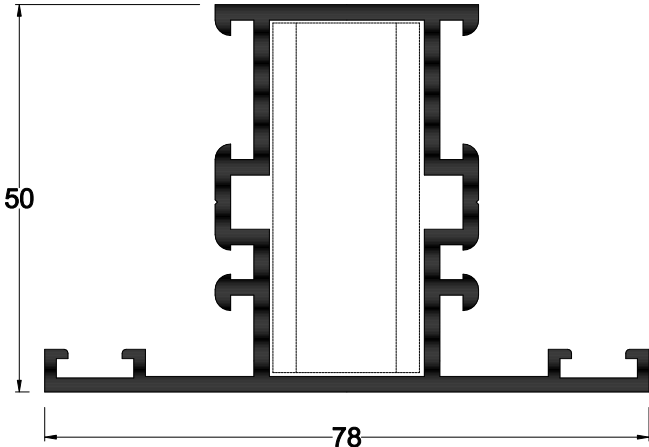

99-1036

AĞIRLIK : 1.390 kg/mt.
JX: 16.46 cm⁴
JY: 15.57 cm⁴

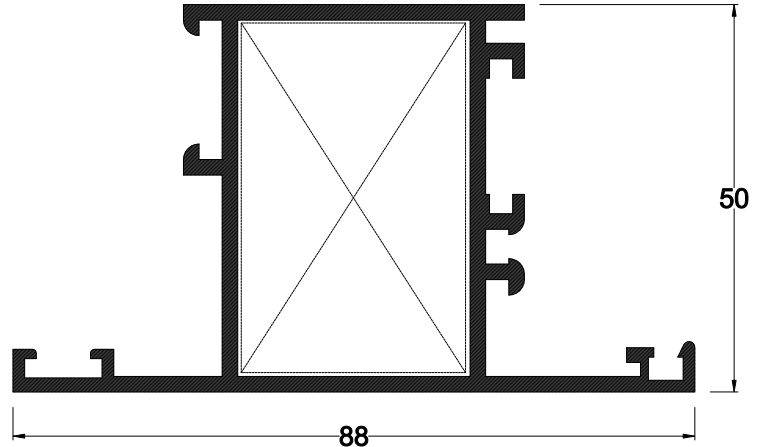

99-1038

AĞIRLIK : 1.450 kg/mt.
JX: 19.25 cm⁴
JY: 23.57 cm⁴

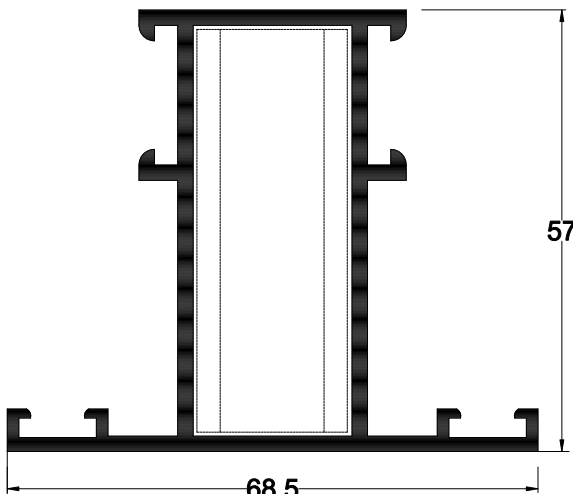

00-1330

AĞIRLIK : 1.285 kg/mt.
JX: 21.60 cm⁴
JY: 11.40 cm⁴

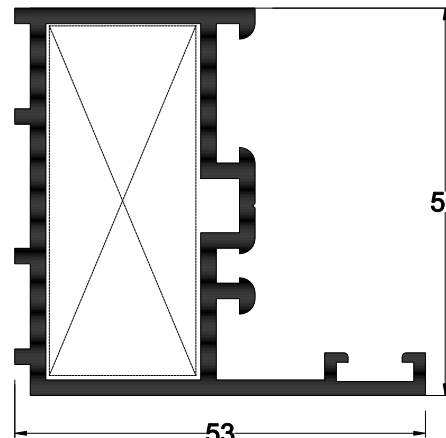

99-1207

26-07-2003 AĞIRLIK : 1.117 kg/mt.
JX: 13.39 cm⁴
JY: 08.40 cm⁴

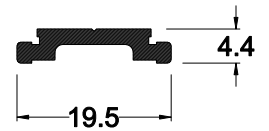

88-033

AĞIRLIK : 0.140 kg/mt.

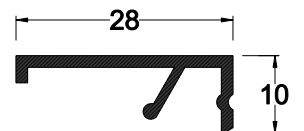

89-109

AĞIRLIK : 0.182 kg/mt.

C 50

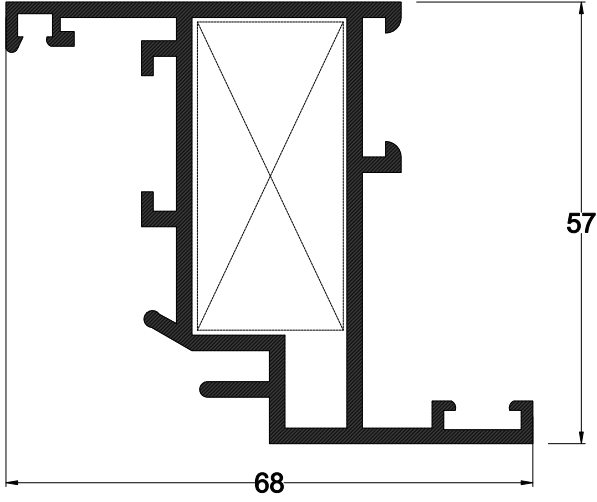

99-1043

AĞIRLIK : 1.350 kg/mt.
JX: 21.58 cm⁴
JY: 11.18 cm⁴

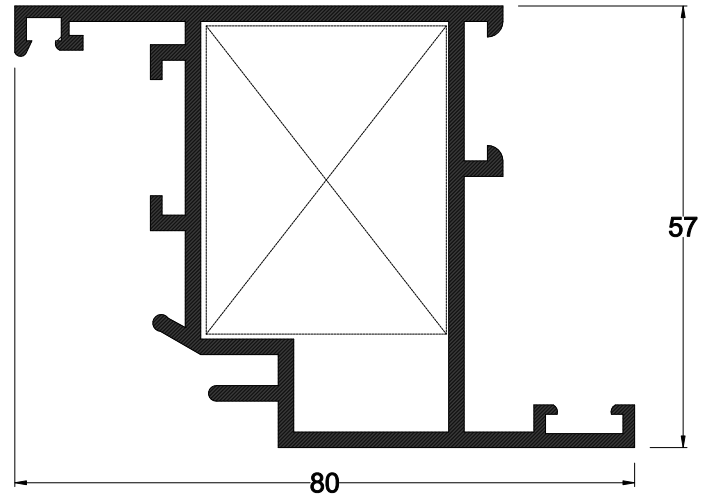

99-1039

AĞIRLIK : 1.472 kg/mt.
JX: 25.22 cm⁴
JY: 20.60 cm⁴

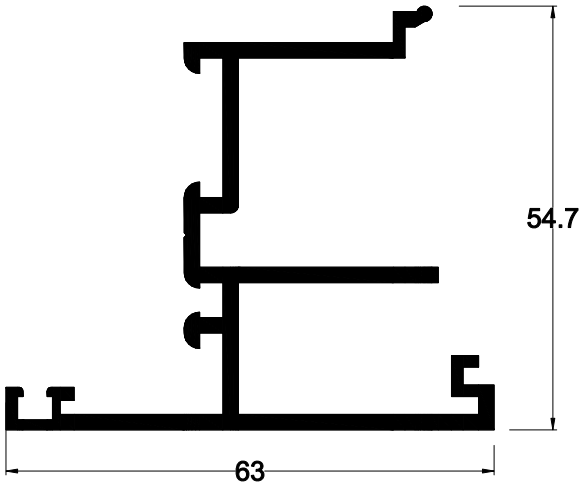

99-1040

AĞIRLIK : 1.114 kg/mt.

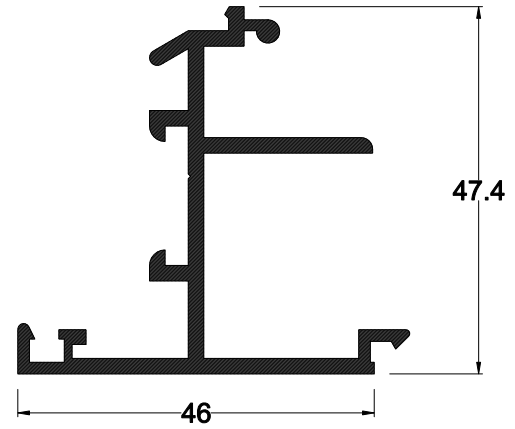

99-1041

AĞIRLIK : 0.795 kg/mt.

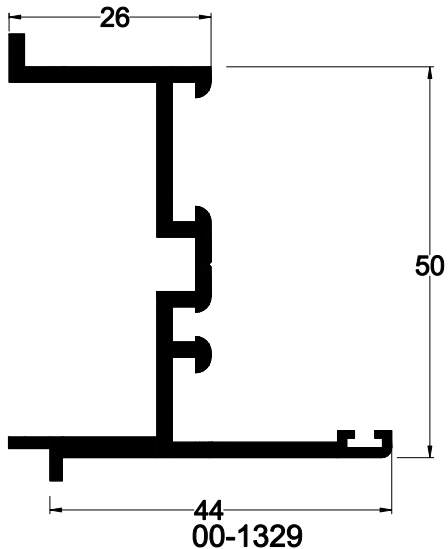

00-1329

AĞIRLIK : 0.832 kg/mt.

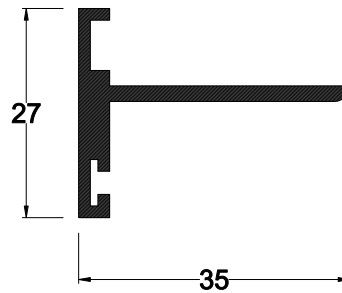

88-027

AĞIRLIK : 0.386 kg/mt.

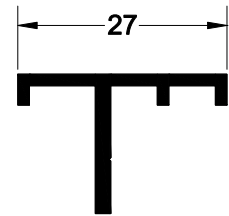

98-967

AĞIRLIK : 0.227 kg/mt.

C 50

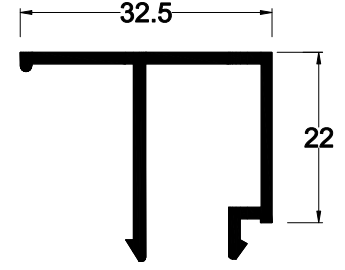
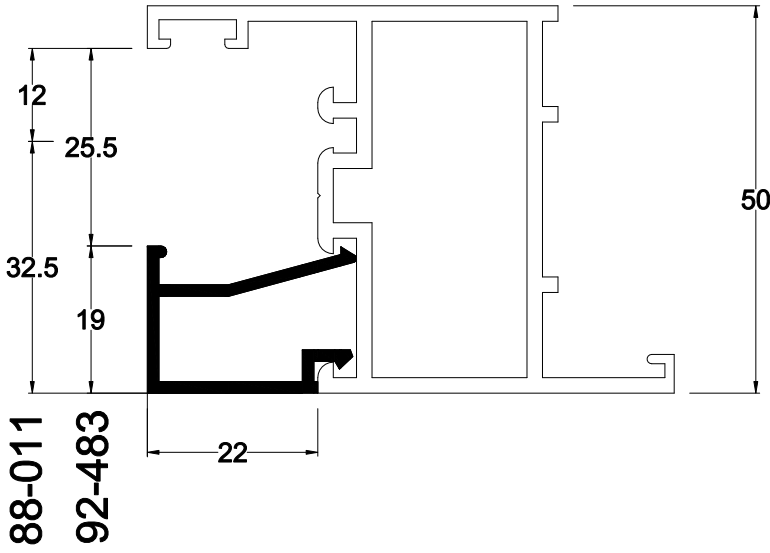

88-011

AĞIRLIK : 0.365 kg/mt.

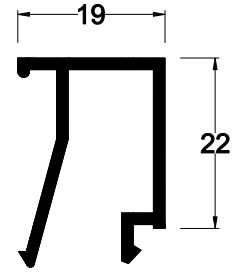

92-483

AĞIRLIK : 0.300 kg/mt.

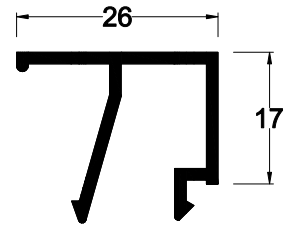
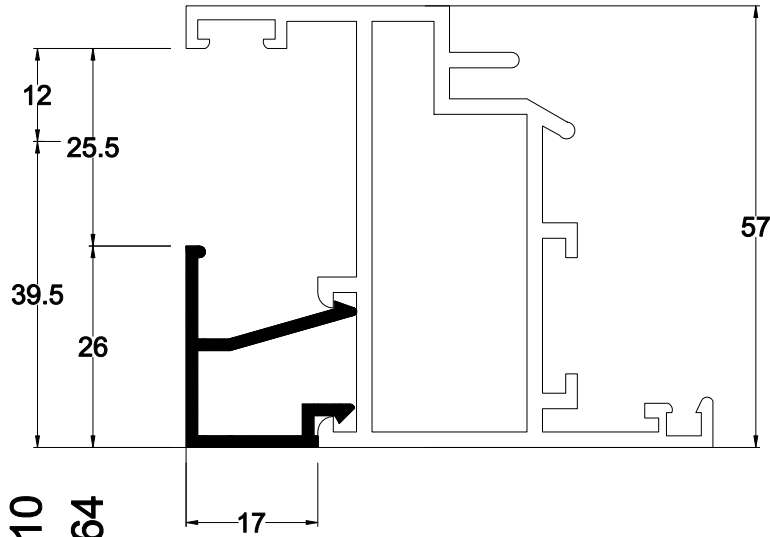

93-564

AĞIRLIK : 0.299 kg/mt.

88-010
93-564

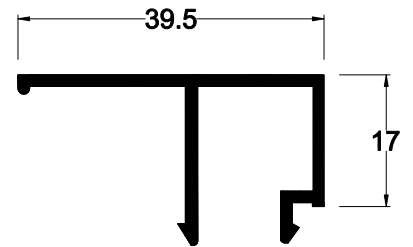

88-010

AĞIRLIK : 0.353 kg/mt.