

03-2014

AĞIRLIK : 1.455 kg/mt.
 JX: 28.12 cm⁴
 JY: 27.44cm⁴

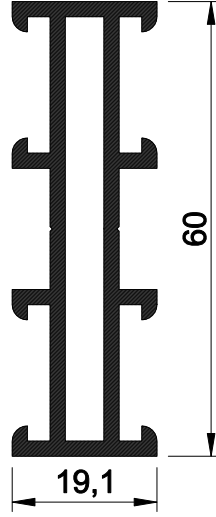

92-430

AĞIRLIK : 1.000 kg/mt.
 JX: 13.67 cm⁴
 JY: 0.90 cm⁴

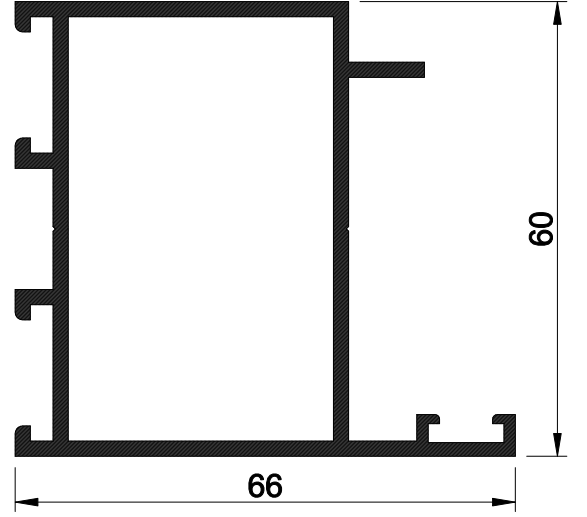

91-309

AĞIRLIK : 1.380 kg/mt.
 JX: 26.57 cm⁴
 JY: 19.20 cm⁴

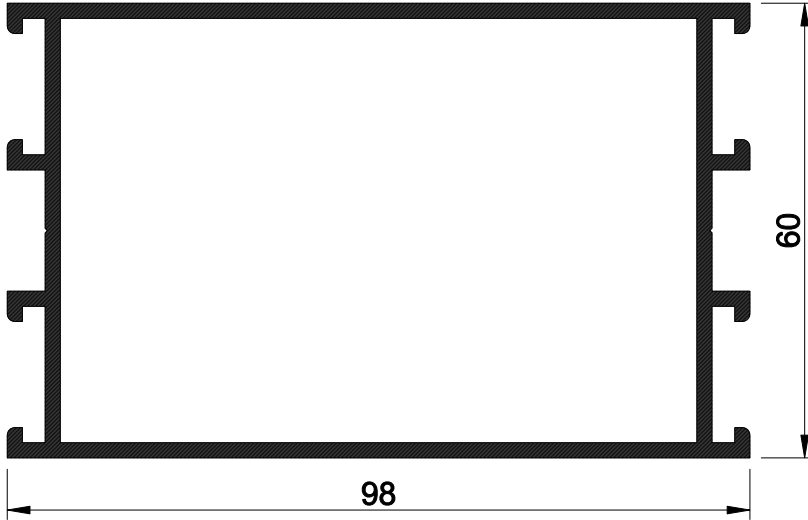

99-1032

AĞIRLIK : 1.845 kg/mt.
 JX: 40.45 cm⁴
 JY: 88.37 cm⁴

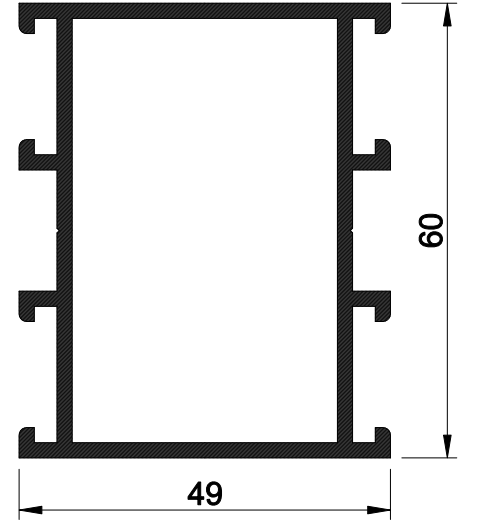

91-310

AĞIRLIK : 1.320 kg/mt.
 JX: 23.96 cm⁴
 JY: 15.20 cm⁴

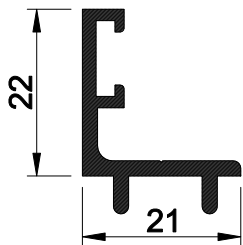

97-864

AĞIRLIK : 0.308 kg/mt.

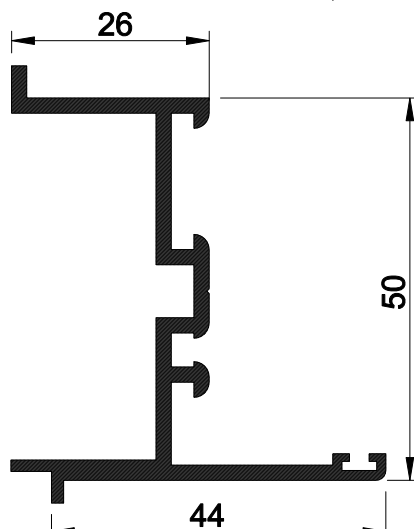

00-1329

AĞIRLIK : 0.832 kg/mt.

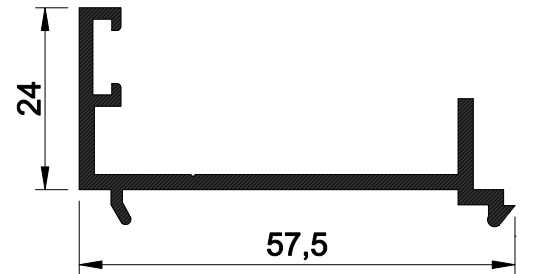

91-308

AĞIRLIK : 0.560 kg/mt.

2

C 60

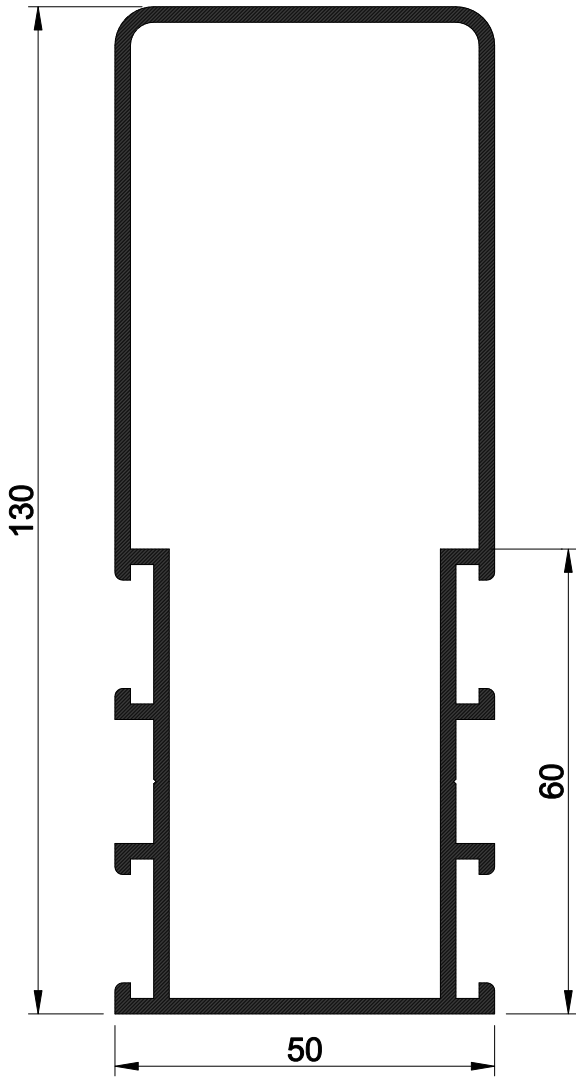

99-1035

AĞIRLIK : 2.108 kg/mt.

JX: 153.05 cm⁴

JY: 31.05 cm⁴



88-023

AĞIRLIK : 0.467 kg/mt.

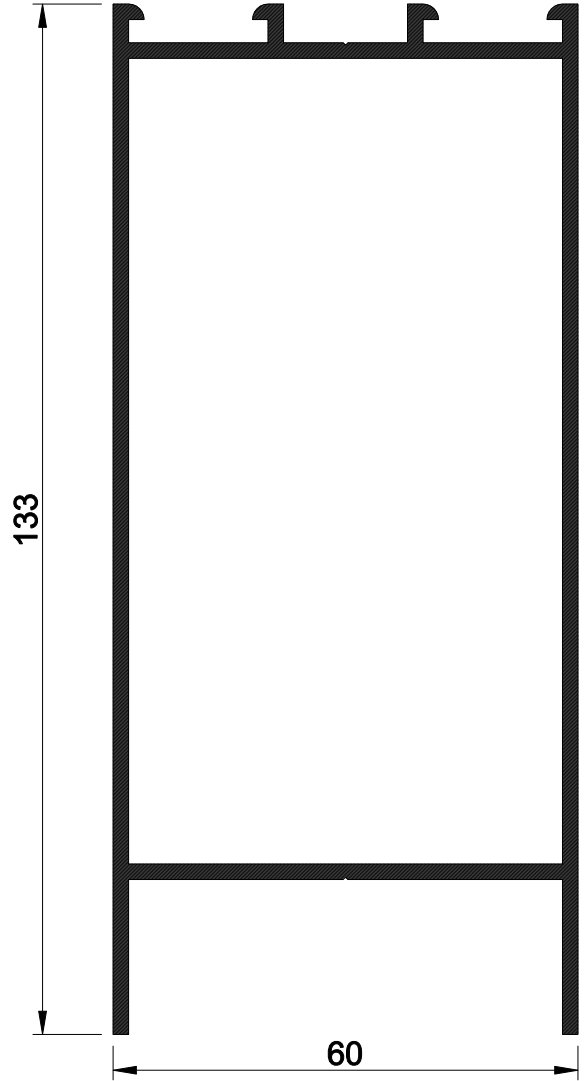

99-1033

AĞIRLIK : 2.140 kg/mt.

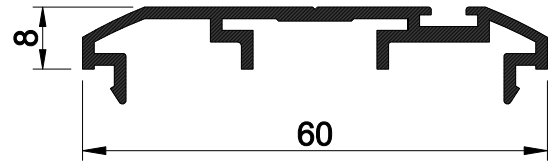

88-024

AĞIRLIK : 0.463 kg/mt.

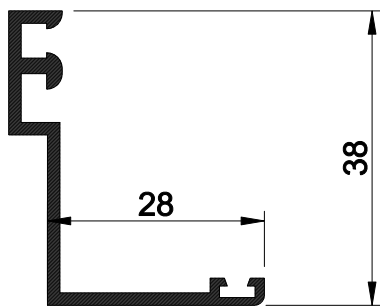

00-1328

AĞIRLIK : 0.372 kg/mt.



00-1327

AĞIRLIK : 0.697 kg/mt.

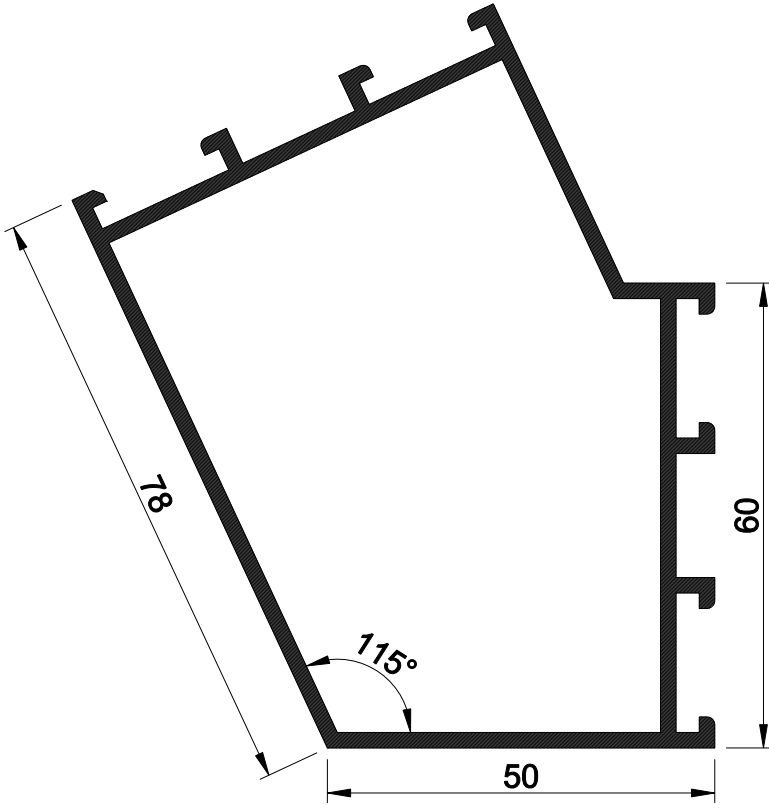

99-1034

AĞIRLIK : 1.756 kg/mt.
 JX: 68.52 cm⁴
 JY: 36.91 cm⁴

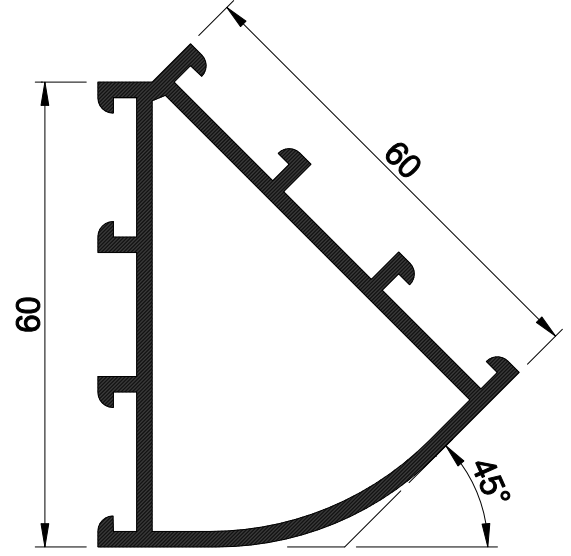

94-600

AĞIRLIK : 1.206 kg/mt.
 JX: 23.90 cm⁴
 JY: 8.50 cm⁴

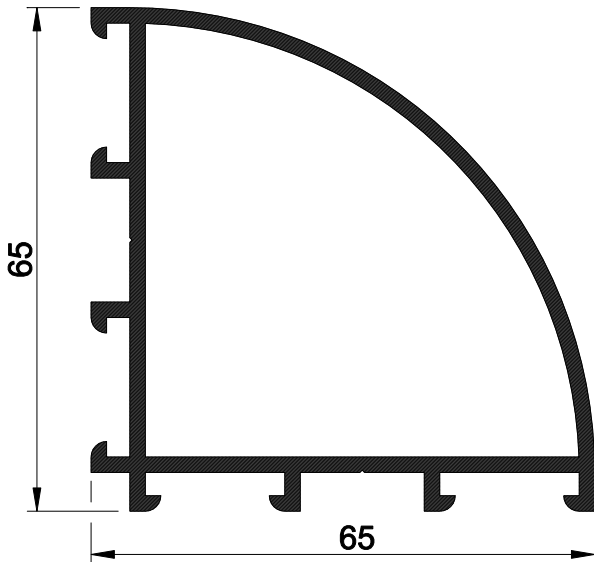

92-436

AĞIRLIK : 1.402 kg/mt.
 JX: 24.74 cm⁴
 JY: 24.74 cm⁴

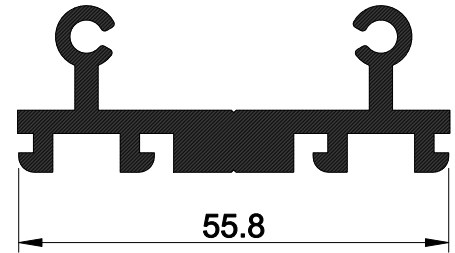

89-191

AĞIRLIK : 1.097 kg/mt.



88-033

AĞIRLIK : 0.130 kg/mt.

C 60

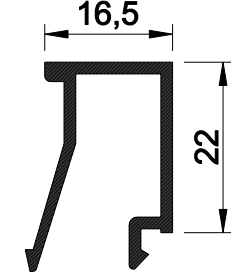
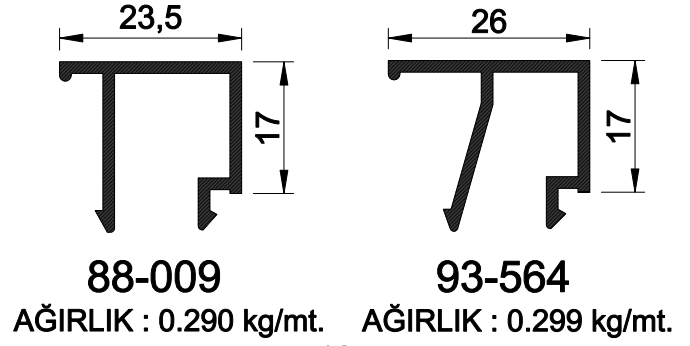
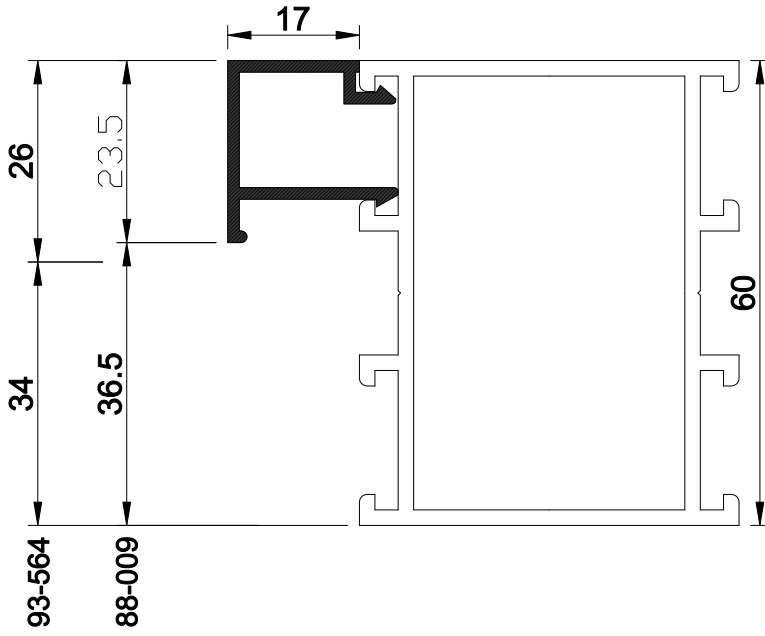

AĞIRLIK : 0.300 kg/mt.

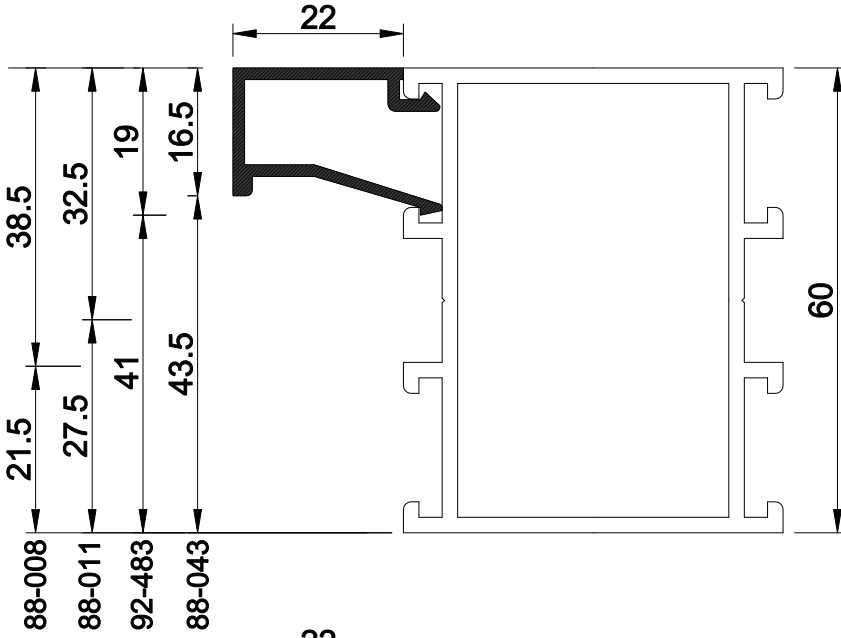

92-483

AĞIRLIK : 0.300 kg/mt.

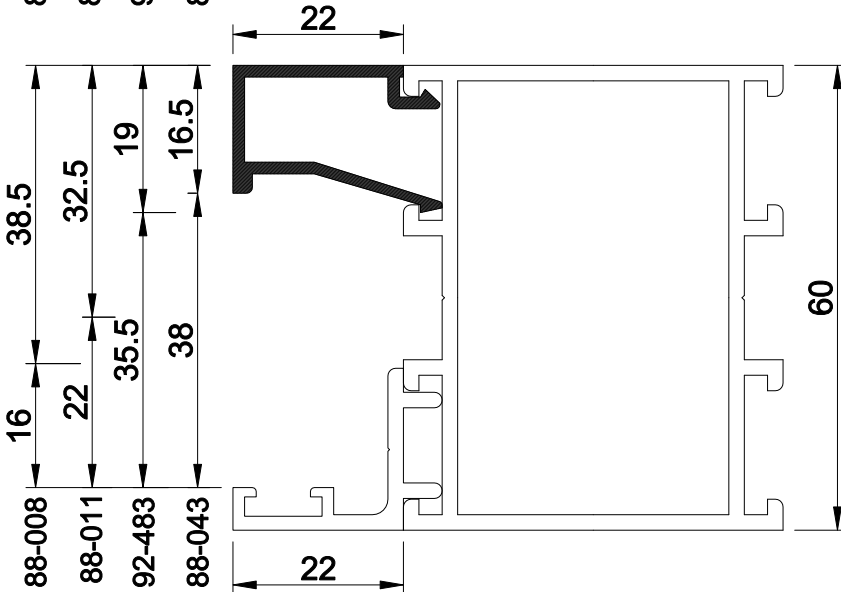

88-011

AĞIRLIK : 0.365 kg/mt.

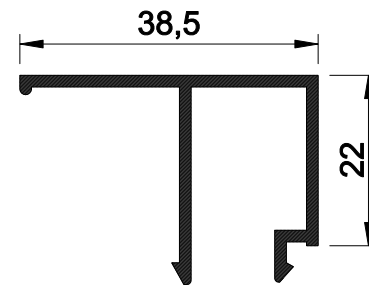

AĞIRLIK : 0.389 kg/mt.