

























NO	PROFİL ŞEKLİ	PROFİL KODU	KALIP NO	AÇIKLAMA	AĞIRLIK (kg/mt.)	SAYFA NO
1		40 E 20	00-1355 00-1350	Kasa Profili	1.074	2
2		40 E 21	00-1355 00-1349	Orta Kayıt Profili	1.177	2
3		40 E 30	00-1351 00-1358	Kanat Profili	1.314	2
4		40 E 22	00-1347 00-1346	Adaptör Profili	1.155	2
5		40 E 61	00-1354	Tij Profili ve Menteşe Adaptör Profili	0.170	2
6		40 E 60	00-1352	Cam Çıtası Adaptör Profili	0.156	2
7		40 E 10	99-1169	Sürme Pencere Kasa Profili	1.248	3
8		40 E 11	00-1357 99-1169	Sürme Pencere Kasa Profili	2.000	3
9		40 E 01	99-1170 99-1171	Sürme Pencere Kanat Profili	1.114	3
10		40 E 50	00-1356 00-1348	DE 40 Sisteme Geçiş Profili	1.624	3
11		40 E 82	99-1168	Sürme Pencere Yan ve Üst Kasa Kapak Pr.	0.313	4
12		40 E 81	99-1167	Sürme Pencere Alt Kasa Kapak Profili	0.307	4
13		40 E 83	99-1216	Sürme Pencere Yan Kasa Kapak Profili	0.478	4
14		40 E 84	99-1217	Sürme Pencere Orta Kanat Bini Profili	0.402	4
15		40 E 85	99-1218	Sürme Pencere Adaptör Profili	0.483	3
16		40 E 80	99-1166	Sürme Pencere Ray Profili	0.129	4
17		40 E 87	99-1224	Sürme Pencere İç Bini Profili	0.195	4
18		40 E 86	99-1223	Sürme Pencere Damlalık Profili	0.180	4
19		40 E 88	00-1317	Sürme Pencere Dış Bini Profili	0.259	4
20		88-033	88-033	Tij Profili	0.130	2
21		40 E 70	99-1215	Cam Çıta Profili	0.275	5
22		40 E 71	00-1386	Cam Çıta Profili	0.202	5
23		40 E 72	00-1384	Cam Çıta Profili	0.340	5
24		97-922	97-922	Köşe Takozu	2.940	4
25		40 E 62	00-1353	Çektirme Profili	0.610	4

NOT : Yukarıdaki profil birim ağırlıkları bilgisayarda tespit edilmiş, teorik ağırlıklardır.

SE 40

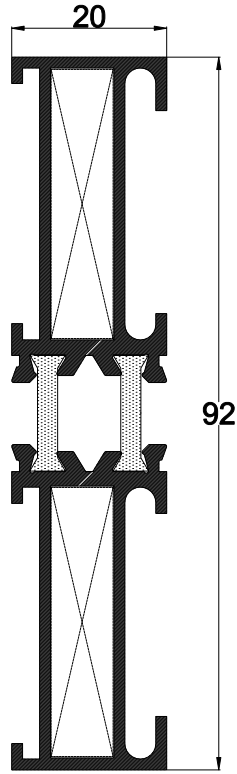
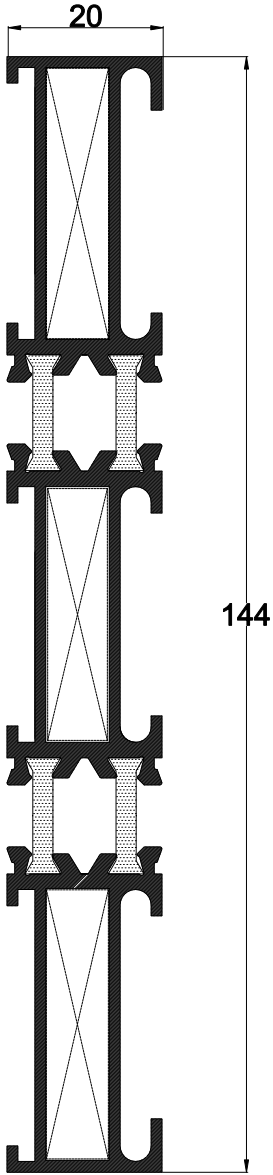

40 E 10
AĞIRLIK : 1.248 kg/mt.
JX: 33.56 cm⁴
JY: 1.49 cm⁴

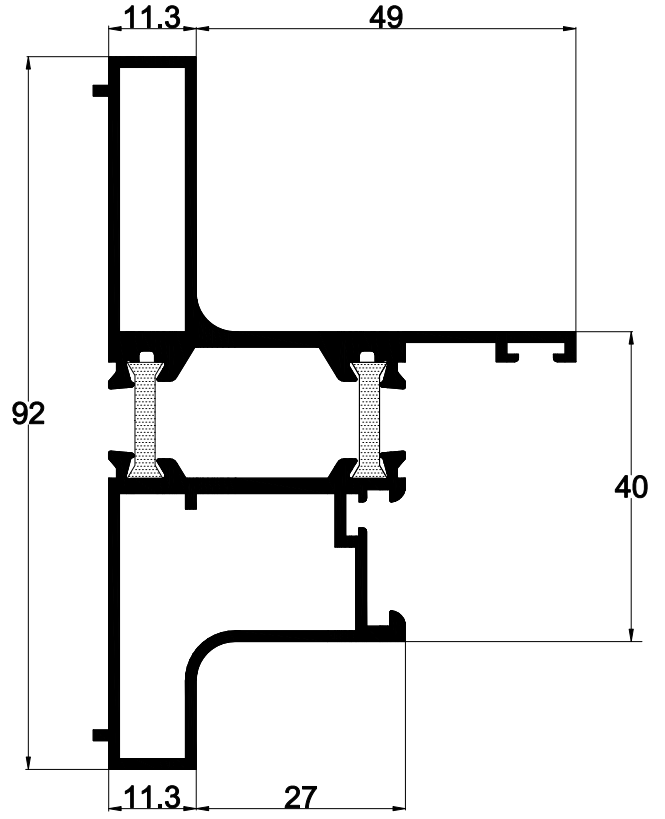

40 E 50
AĞIRLIK : 1.624 kg/mt.
JX: 29.43 cm⁴
JY: 13.48 cm⁴

40 E 11
AĞIRLIK : 2.000 kg/mt.
JX: 118.77 cm⁴
JY: 2.33 cm⁴

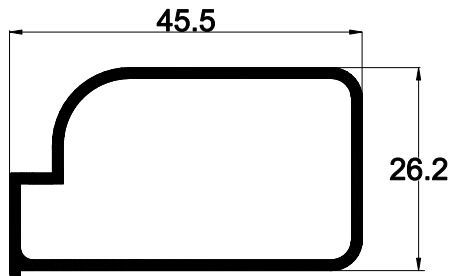

40 E 85
AĞIRLIK : 0.502 kg/mt.
JX: 19.67 cm⁴
JY: 46.59 cm⁴

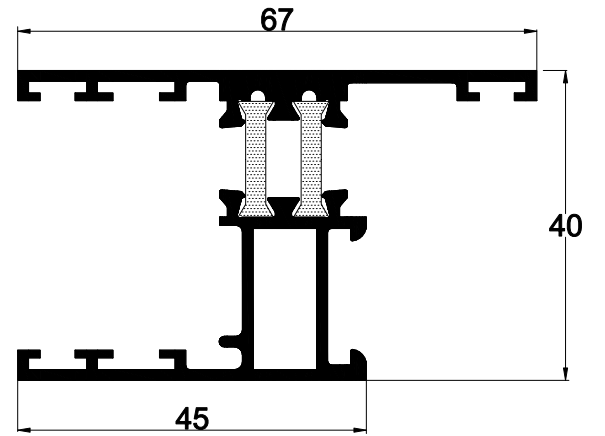

40 E 01
AĞIRLIK : 1.114 kg/mt.
JX: 9.37 cm⁴
JY: 8.58 cm⁴

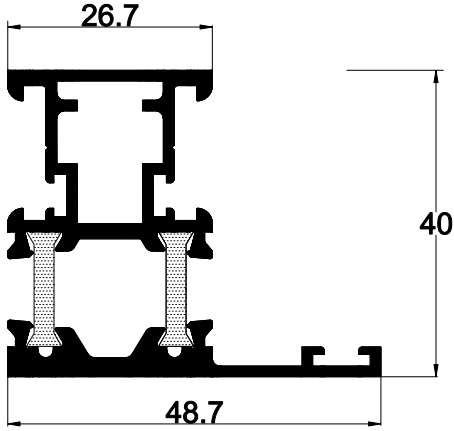

40 E 20

AĞIRLIK : 1.074 kg/mt.
JX: 7.23 cm⁴
JY: 4.64 cm⁴

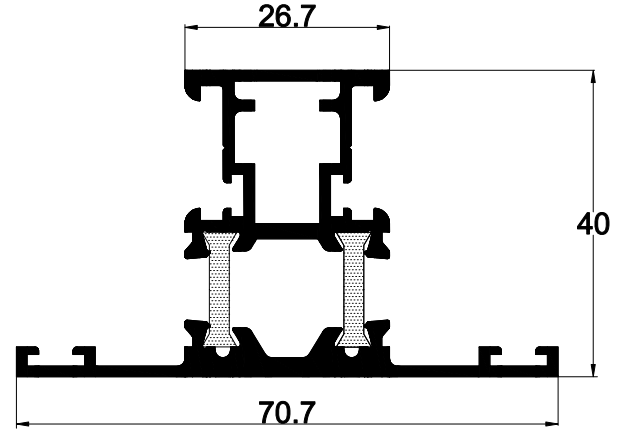

40 E 21

AĞIRLIK : 1.177 kg/mt.
JX: 8.08 cm⁴
JY: 7.83 cm⁴

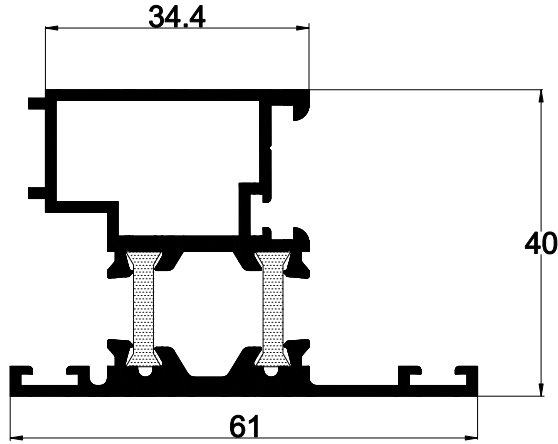

40 E 22

AĞIRLIK : 1.155 kg/mt.
JX: 8.00 cm⁴
JY: 7.58 cm⁴

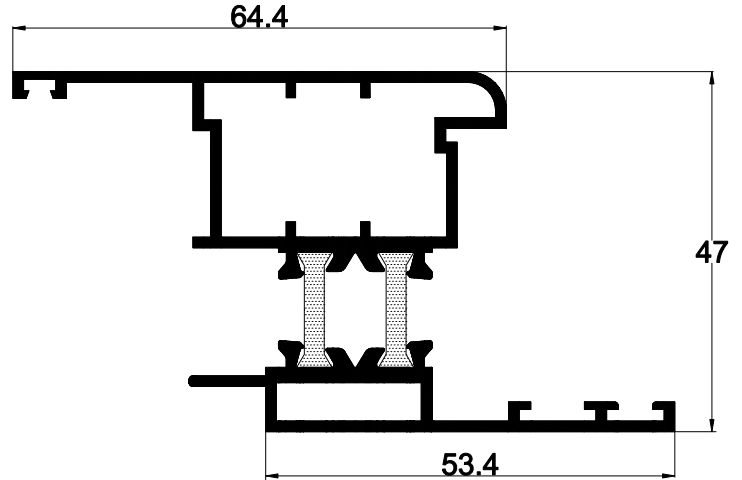

40 E 30

AĞIRLIK : 1.314 kg/mt.
JX: 13.28 cm⁴
JY: 13.99 cm⁴

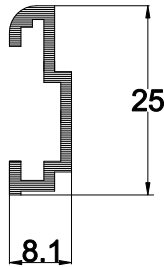

40 E 61

AĞIRLIK : 0.170 kg/mt.

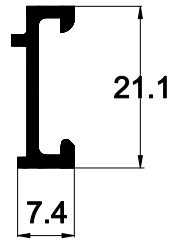

40 E 60

AĞIRLIK : 0.156 kg/mt.



88-033

AĞIRLIK : 0.140 kg/mt.

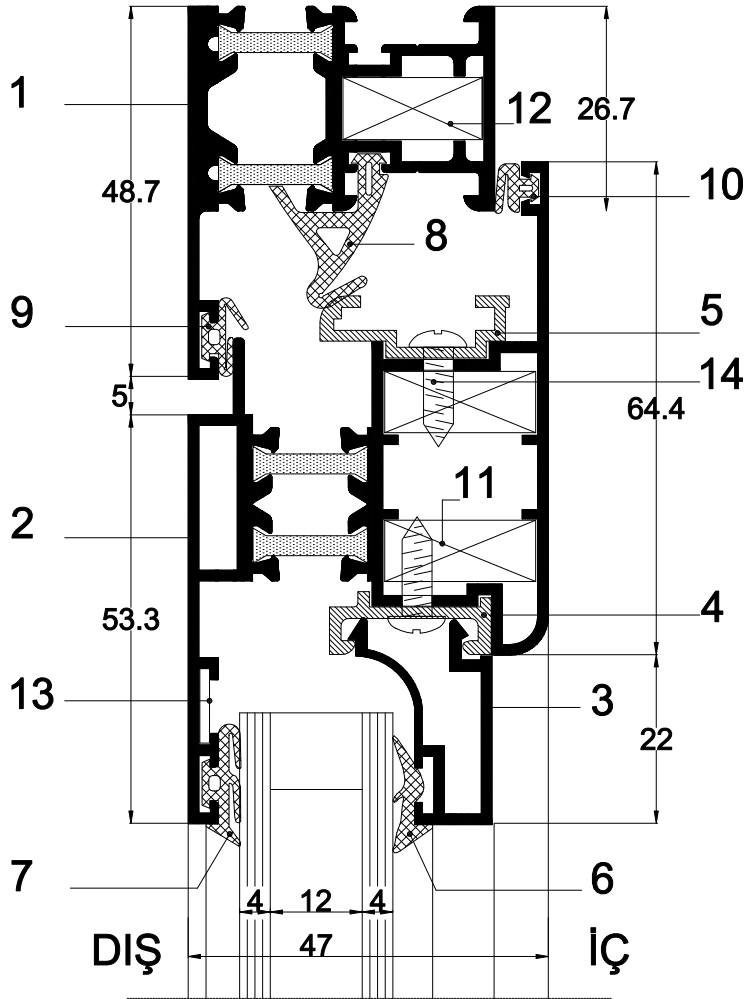

3 DETAYI

1. Kasa Profili	40 E 20	9. Dış Bini Fiteli	40 D 08
2. Kanat Profili	40 E 30	10. İç Bini Fiteli	40 D 06
3. Cam Çita Profili	40 E 70	11. Köşe Takoza	97-922 (19.7 mm)
4. Çita Adaptor Profili	40 E 60	12. Köşe Takoza	97-922 (18.0 mm)
5. Men.ve Tij Pr. Adp. Pr.	40 E 61	13. Köşe Gönyesi	40 D 21
6. İç Cam Fiteli	40 D 03	14. Vida 4.2x13 mm	(Paslanmaz)
7. Dış Cam Fiteli	40 D 02		
8. Kasa Takoza Fiteli	40 D 07		

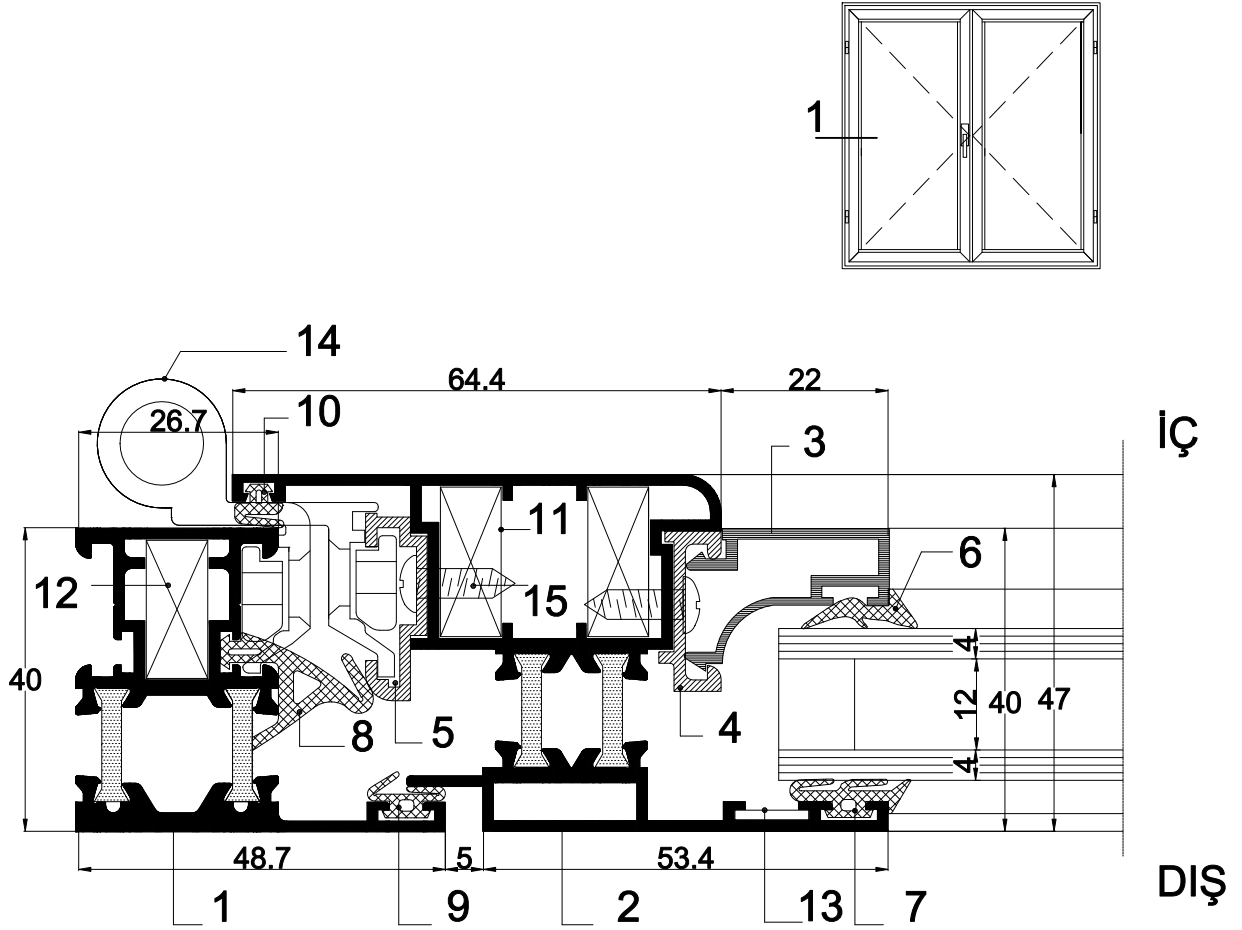

1 DETAYI

1. Kasa Profili	40 E 20	9. Dış Bini Fitili	40 D 08
2. Kanat Profili	40 E 30	10. İç Bini Fitili	40 D 06
3. Cam Çita Profili	40 E 70	11. Köşe Takoza	97-922 (19.7 mm)
4. Çita Adaptor Profili	40 E 60	12. Köşe Takoza	97-922 (18.0 mm)
5. Men.ve Tij Pr. Adp. Pr.	40 E 61	13. Köşe Gönyesi	40 D 21
6. İç Cam Fitili	40 D 03	14. Menteşe	40 D 22
7. Dış Cam Fitili	40 D 02	15. Vida	4.2x13 mm (Paslanmaz)
8. Kasa Takoza Fitili	40 D 07		

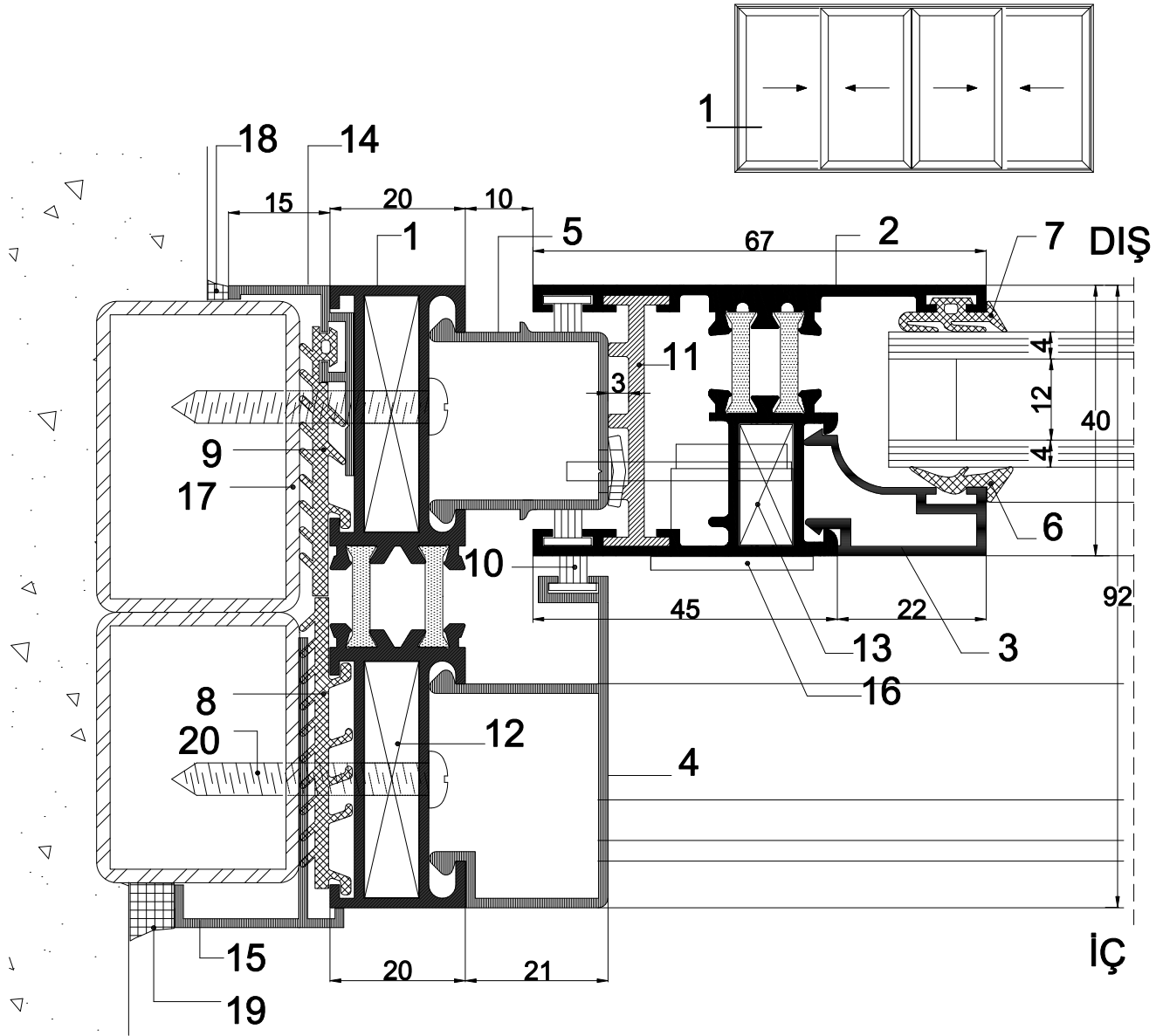

1 DETAYI

1. Kasa Profili	40 E 10	11. Sert Plastik Stoper	40 D 11
2. Kanat Profili	40 E 01	12. Köşe Takozu	97-922 (34.6 mm)
3. Cam Çıta Profili	40 E 70	13. Köşe Takozu	97-922 (17.6 mm)
4. Yan Kasa Kapak Profili	40 E 83	14. İç Bini Profili	40 E 87
5. Yan ve Üst Kasa Kapak Profili	40 E 82	15. Dış Bini Profili	40 E 88
6. İç Cam Fitali	40 D 03	16. Havuzlu Kilit	40 D 28
7. Dış Cam Fitali	40 D 02	17. Körkasa	
8. Fital	40 D 09	18. Silikon	
9. Fital	40 D 10	19. 602 Çekomastik (Beyaz-Kahverengi-Siyah)	
10. Fırça Fitali	40 D 04	20. Vida 4.8x38 mm (Paslanmaz)	

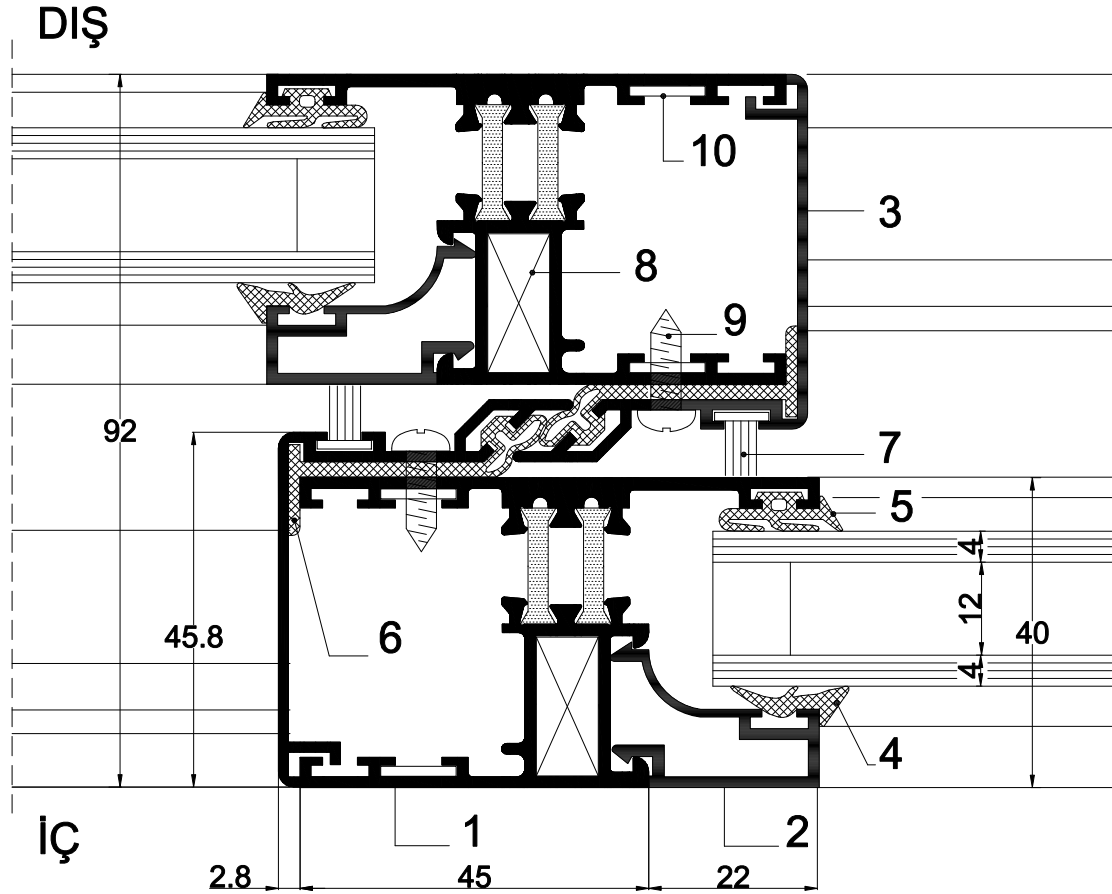
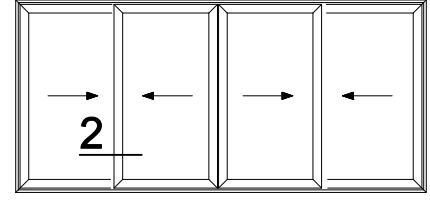

2 DETAYI

1. Kanat Profili	40 E 01	6. Fitol	40 D 01
2. Cam Çita Profili	40 E 70	7. Fırça Fitol	40 D 25
3. Orta Kanat Bini Profili	40 E 84	8. Köşe Takoðu	97-922 (17.6 mm)
4. İç Cam Fitol	40 D 03	9. Vida 4.2x13 mm (Paslanmaz)	
5. Dış Cam Fitol	40 D 02	10. Köşe Gönyesi	40 D 21

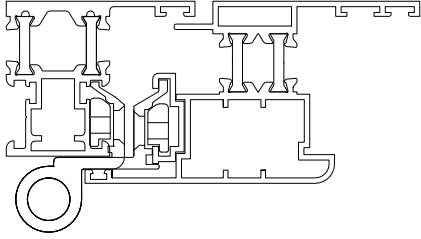

40 D 22
MENTEŞE
Ö:1/2

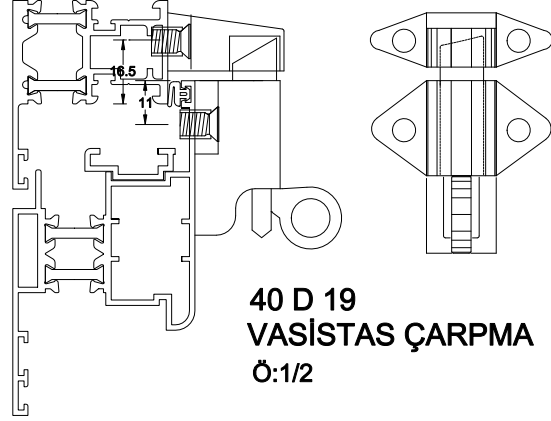

40 D 19
VASİSTAS ÇARPMA
Ö:1/2

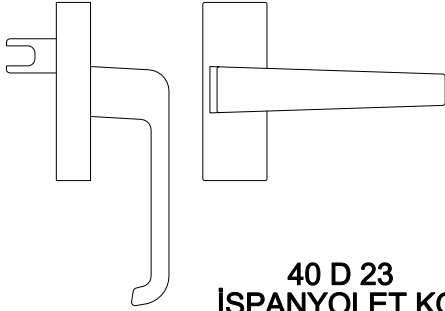

40 D 23
İSPANYOLET KOL
1314 - 1264

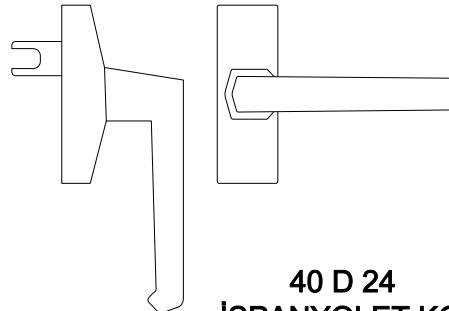

40 D 24
İSPANYOLET KOL
1316 - 1268

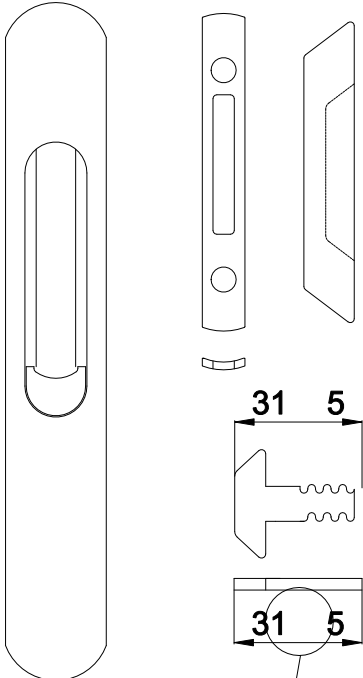

ÖLÇÜSÜ VE ŞEKLİ, SİSTEMLERE
GÖRE FARKLILIK GÖSTERİYOR.

40 D 28
HAVUZLU KİLİT
GIESSE BRIO MINI
PENCERE İÇİN
Ö:1/2

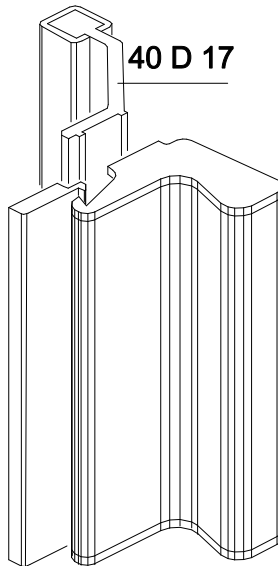

40 D 16
KLEPSLİ KİLİT
Ö:1/2

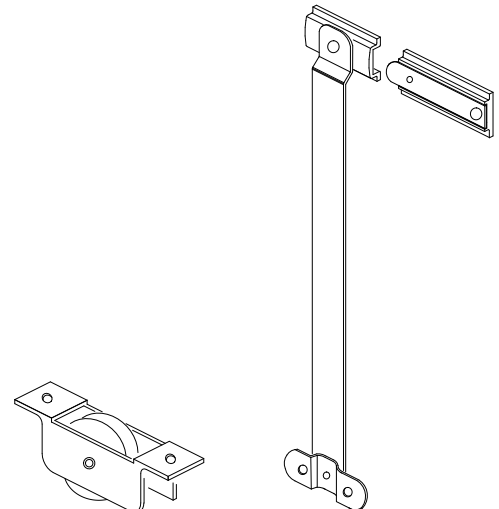

40 D 20
RULMAN
Ö:1/2

40 D 18
VASİSTAS MAKAS
Ö:1/3

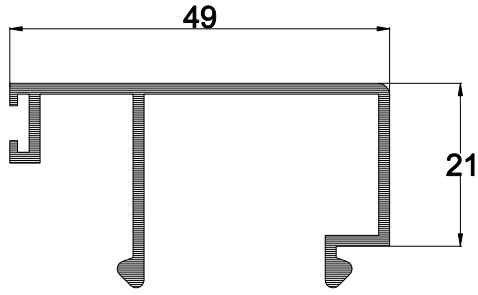

40 E 83
AĞIRLIK : 0.478 kg/mt.

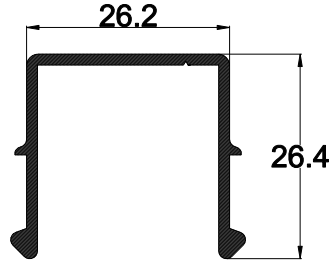

40 E 82
AĞIRLIK : 0.313 kg/mt.

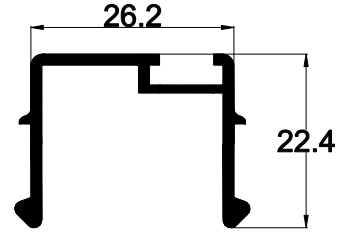

40 E 81
AĞIRLIK : 0.307 kg/mt.

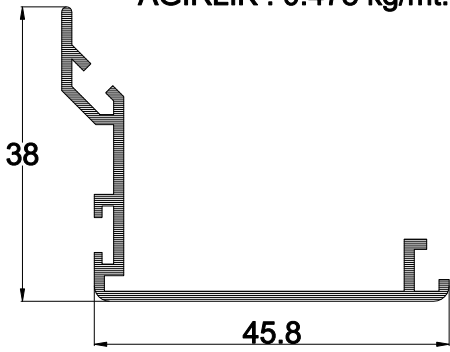

40 E 84
AĞIRLIK : 0.402 kg/mt.

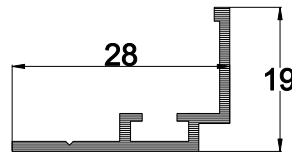

40 E 87
AĞIRLIK : 0.195 kg/mt.

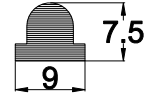

40 E 80
AĞIRLIK : 0.129 kg/mt.

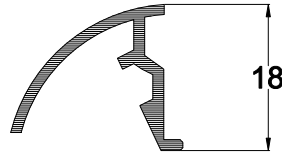

40 E 86
AĞIRLIK : 0.180 kg/mt.

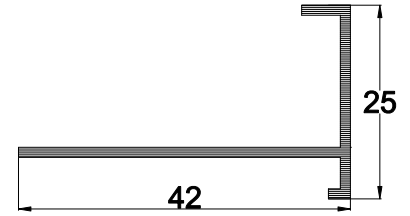

40 E 88
AĞIRLIK : 0.259 kg/mt.

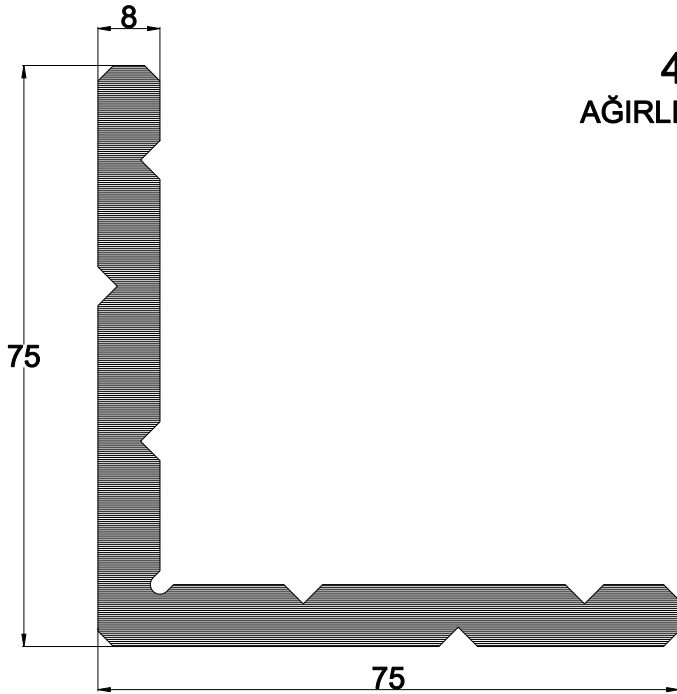

97-922
AĞIRLIK : 2.940 kg/mt.

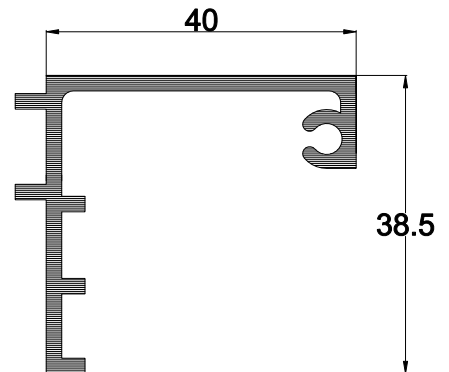

40 E 62
AĞIRLIK : 0.610 kg/mt.

SE 40

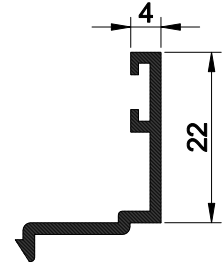
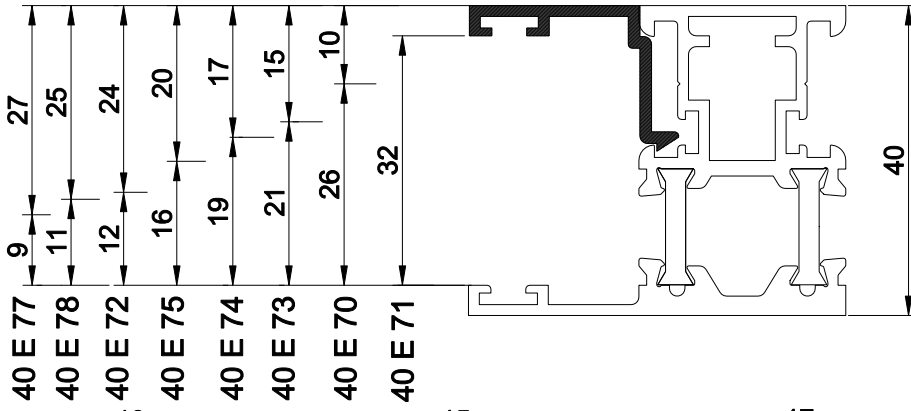

40 E 71
AĞIRLIK : 0.197 kg/mt.

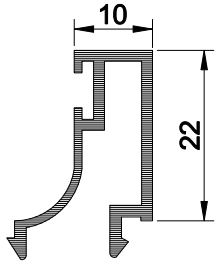

40 E 70
AĞIRLIK : 0.275 kg/mt.

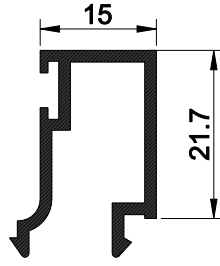

40 E 73
AĞIRLIK : 0.310 kg/mt.

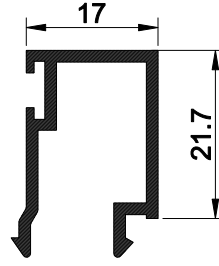

40 E 74
AĞIRLIK : 0.313 kg/mt.

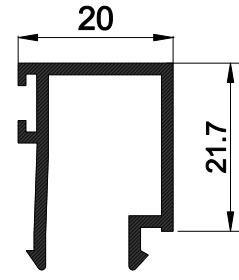

40 E 75
AĞIRLIK : 0.323 kg/mt.

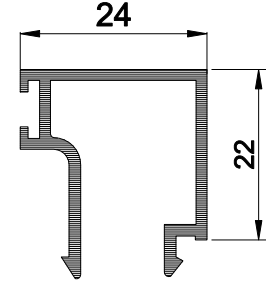

40 E 72
AĞIRLIK : 0.340 kg/mt.

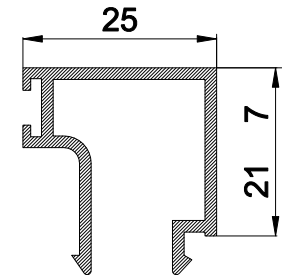

40 E 78
AĞIRLIK : 0.359 kg/mt.

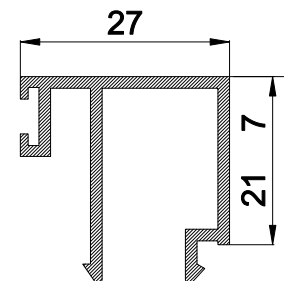

40 E 77
AĞIRLIK : 0.388 kg/mt.

Malzeme Kalınlığı	Çıta Profili	İç Cam Fitili	Dış Cam Fitili
3 mm	40 E 77	40 D 03 (3mm)	40 D 02 (3mm)
4 mm	40 E 78	40 D 05 (4mm)	40 D 02 (3mm)
6 mm	40 E 72	40 D 03 (3mm)	40 D 02 (3mm)
10 mm	40 E 75	40 D 03 (3mm)	40 D 02 (3mm)
12 mm	40 E 74	40 D 05 (4mm)	40 D 02 (3mm)
14 mm	40 E 73	40 D 05 (4mm)	40 D 02 (3mm)
15 mm	40 E 73	40 D 03 (3mm)	40 D 02 (3mm)
18 mm	40 E 70	40 D 05 (4mm)	40 D 02 (3mm)
20 mm	40 E 70	40 D 03 (3mm)	40 D 02 (3mm)
24 mm	40 E 71	40 D 05 (4mm)	40 D 02 (3mm)

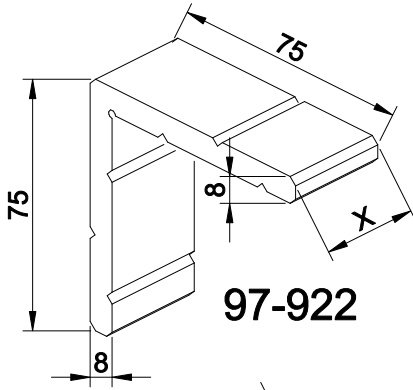

97-922

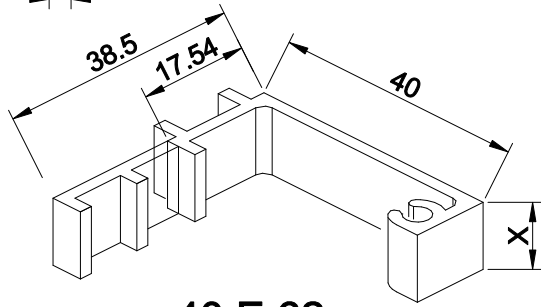

40 E 62

KÖŞE TAKOZLARI

Köşe Takozu Profil No:	Kesim Boyu (X)	Profil Kodu
97-922	18.0 mm	40 E 20 / 40 E 21
	17.6 mm	40 E 01
	19.7 mm	40 E 30
	34.6 mm	40 E 10
	33.6 mm	40 E 50
	32.5 mm 34.6 mm	40 E 11

ÇEKTİRME PROFİLİ

Çektirme Profili No:	Kesim Boyu (X)	Profil Kodu
40 E 62	8.0	40 E 21

! NOT: KÖŞE TAKOZLARI VE ÇEKTİRME PROFİLİ ÇEKOBOND (BEYAZ-KAHVERENGİ) (EPOKSLİ) SÜRÜLEREK TAKILIR.



40 D 05 (4mm için)
E.P.D.M. CAM FİTİLİ



40 D 03 (3mm için)
E.P.D.M. CAM FİTİLİ



40 D 02 (3mm için)
E.P.D.M. DIŞ CAM FİTİLİ



40 D 06
E.P.D.M. BİNİ FİTİLİ



40 D 07
E.P.D.M.
KASA TAKOZ FİTİLİ



40 D 08
E.P.D.M. BİNİ FİTİLİ

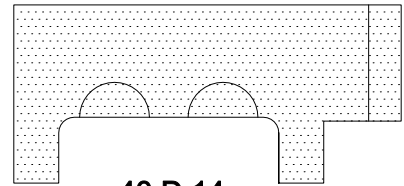
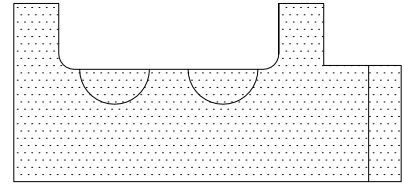

40 D 14
PLASTİK TAPA



40 D 09
E.P.D.M.
KASA TAKOZ FİTİLİ

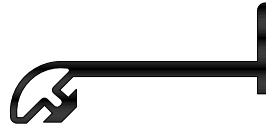

40 D 01
E.P.D.M
ORTA BİNİ FİTİLİ



40 D 10
E.P.D.M
KASA TAKOZ FİTİLİ



40 D 04
FİRÇA FİTİLİ

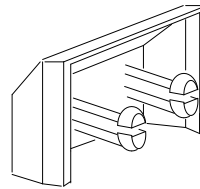

40 D 13
YAĞMUR TAHLİYE
KAPAĞI

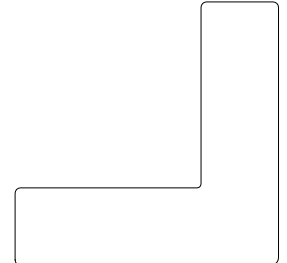

40 D 21
KÖŞE GÖNYESİ

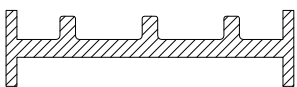

40 D 11
SERT PLASTİK STOPER

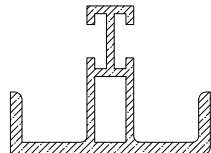

40 D 12
SERT PLASTİK TOZ TUTUCU

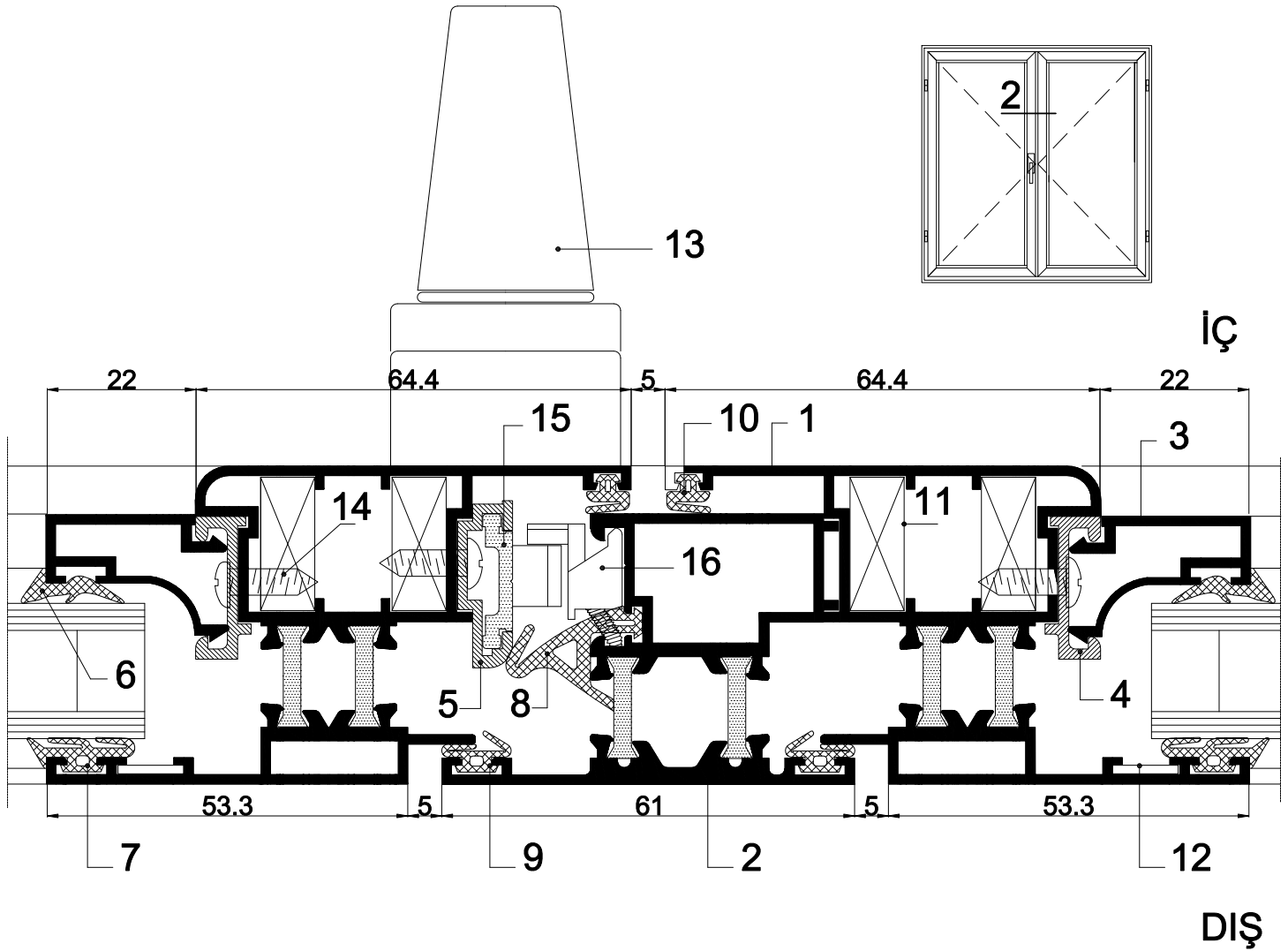

2 DETAYI

1. Kanat Profili	40 E 30	9. Dış Bini Fiteli	40 D 08
2. Adaptör Profili	40 E 22	10. İç Bini Fiteli	40 D 06
3. Cam Çita Profili	40 E 70	11. Köşe Takoza	97-922 (19.7 mm)
4. Çita Adaptör Profili	40 E 60	12. Köşe Gönyesi	40 D 21
5. Men.ve Tij Pr. Adp. Pr.	40 E 61	13. İspanyolet Kol	40 D 23 veya 40 D 24
6. İç Cam Fiteli	40 D 03	14. Vida 4.2x13 mm (Paslanmaz)	
7. Dış Cam Fiteli	40 D 02	15. Tij Profili	88-033
8. Kasa Takoz Fiteli	40 D 07	16. Ayarlı Karşılık	

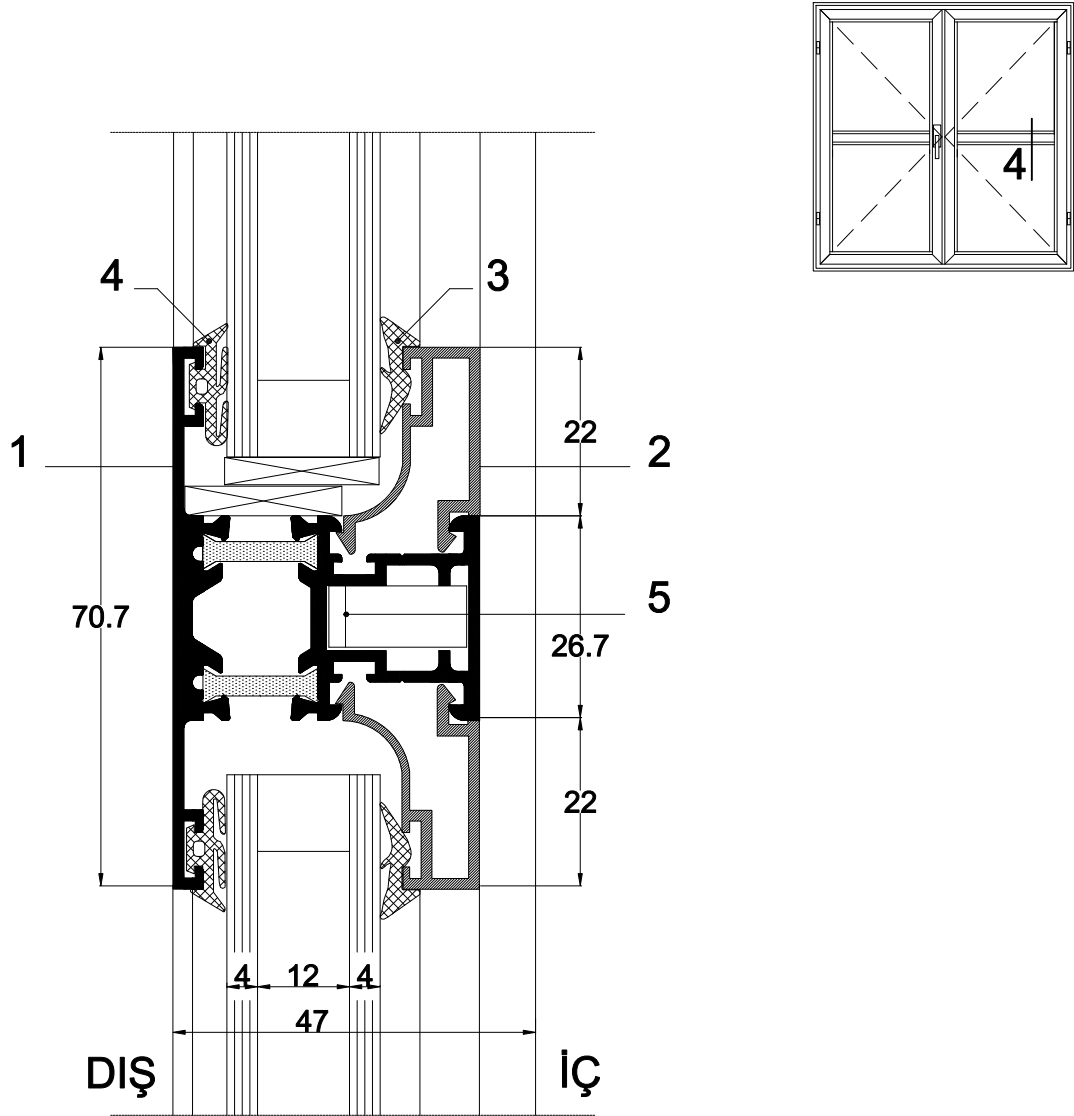
**4** DETAYI

1. Kayıt Profili	40 E 21	4. Dış Cam Fitiği	40 D 02
2. Cam Çita Profili	40 E 70	5. Çektirme Profili	40 E 62 (8.0 mm)
3. İç Cam Fitiği	40 D 03		

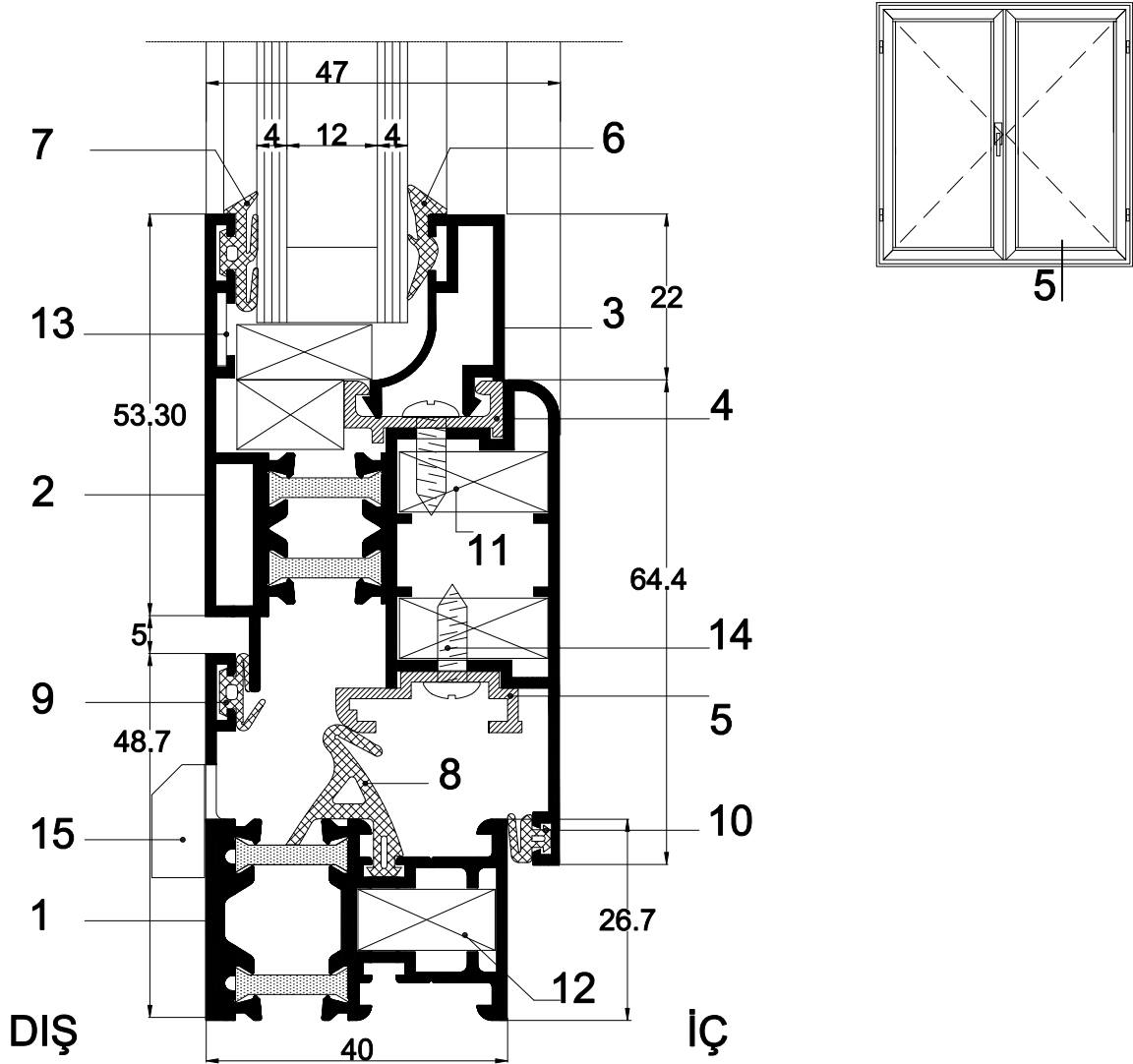

5 DETAYI

1. Kasa Profili	40 E 20	9. Dış Bini Fitili	40 D 08
2. Kanat Profili	40 E 30	10. İç Bini Fitili	40 D 06
3. Cam Çita Profili	40 E 70	11. Köşe Takozu	97-922 (19.7mm)
4. Çita Adaptor Profili	40 E 60	12. Köşe Takozu	97-922 (18mm)
5. Men.ve Tij Pr. Adp. Pr.40 E 61		13. Köşe Gönyesi	40 D 21
6. İç Cam Fitili	40 D 03	14. Vida	4.2x13 mm (Paslanmaz)
7. Dış Cam Fitili	40 D 02	15. Yağmur Tahliye Kapağı	40 D 13
8. Kasa Takoz Fitili	40 D 07		

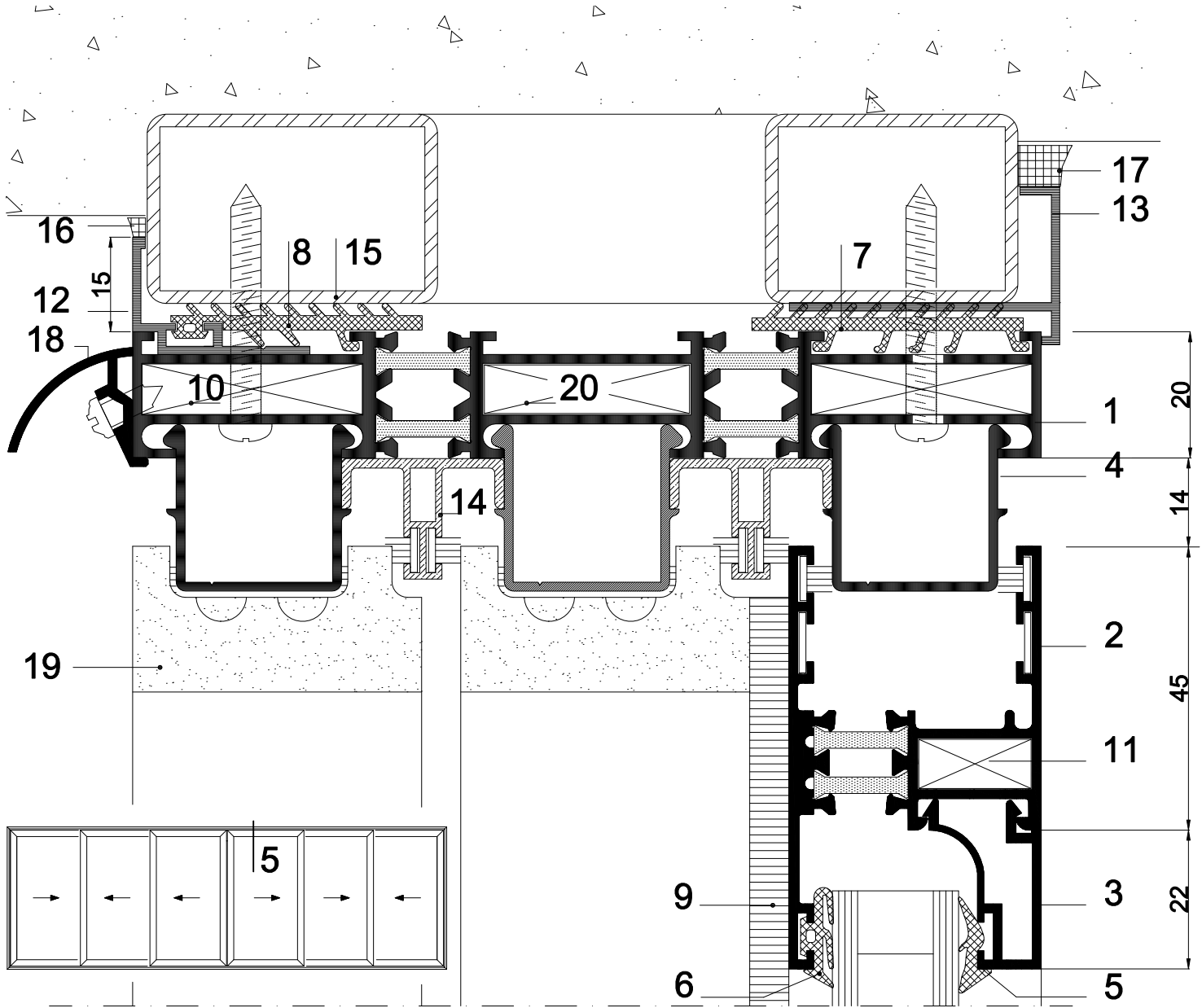

DIŞ

5 DETAYI

İÇ

1. Kasa Profili	40 E 11	10. Köşe Takozu	97-922 (34.6 mm)
2. Kanat Profili	40 E 01	11. Köşe Takozu	97-922 (17.6 mm)
3. Cam Çıta Profili	40 E 70	12. İç Bini Profili	40 E 87
4. Yan ve Üst Kasa Kapak Profili	40 E 82	13. Dış Bini Profili	40 E 88
5. İç Cam Fiteli	40 D 03	14. Toz Tutucu	40 D 12
6. Dış Cam Fiteli	40 D 02	15. Körkasa	
7. Fitol	40 D 09	16. Silikon	
8. Fitol	40 D 10	17. 602 Çekomastik (Beyaz-Kahverengi-Siyah)	
9. Fırça Fitol	40 D 25	18. Damlalık Profili	40 E 86
		19. Plastik Tapa	40 D 14
		20. Köşe Takozu	97-922 (32.5 mm)

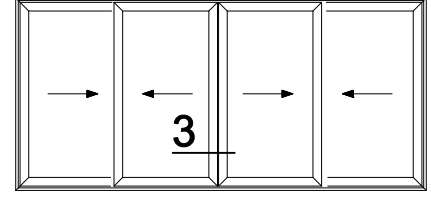

DIŞ

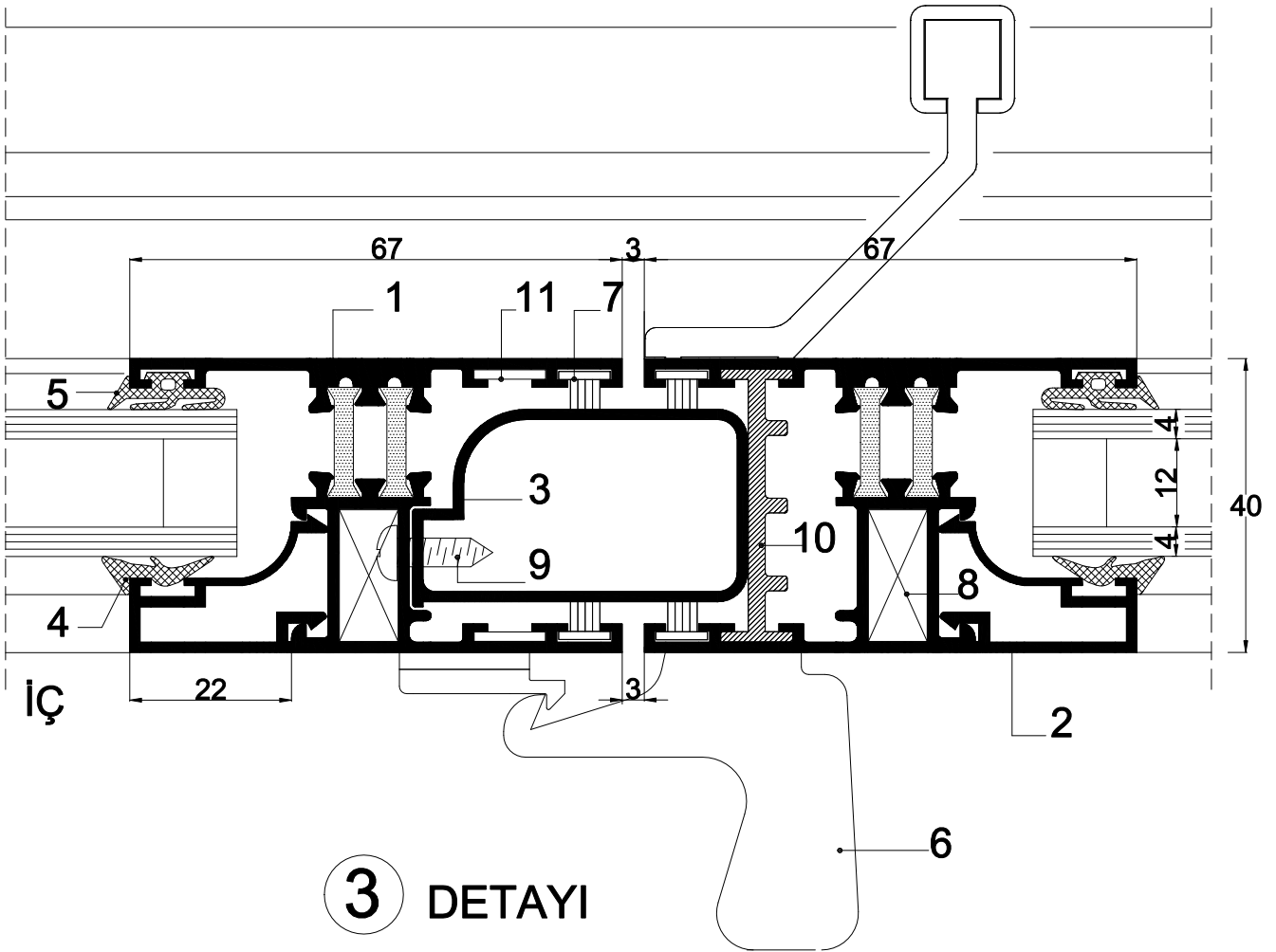

3 DETAYI

1. Kanat Profili	40 E 01	6. Klepsli Kilit	40 D 16 - 40 D 17
2. Cam Çıta Profili	40 E 70	7. Fırça Fitol	40 D 04
3. Orta Kanat Adaptör Profili	40 E 85	8. Köşe Takoğu	97-922 (17.6 mm)
4. İç Cam Fitol	40 D 03	9. Vida 4.2x13 mm (Paslanmaz)	
5. Dış Cam Fitol	40 D 02	10. Sert Plastik Stoper	40 D 11
		11. Köşe Gönyesi	40 D 21

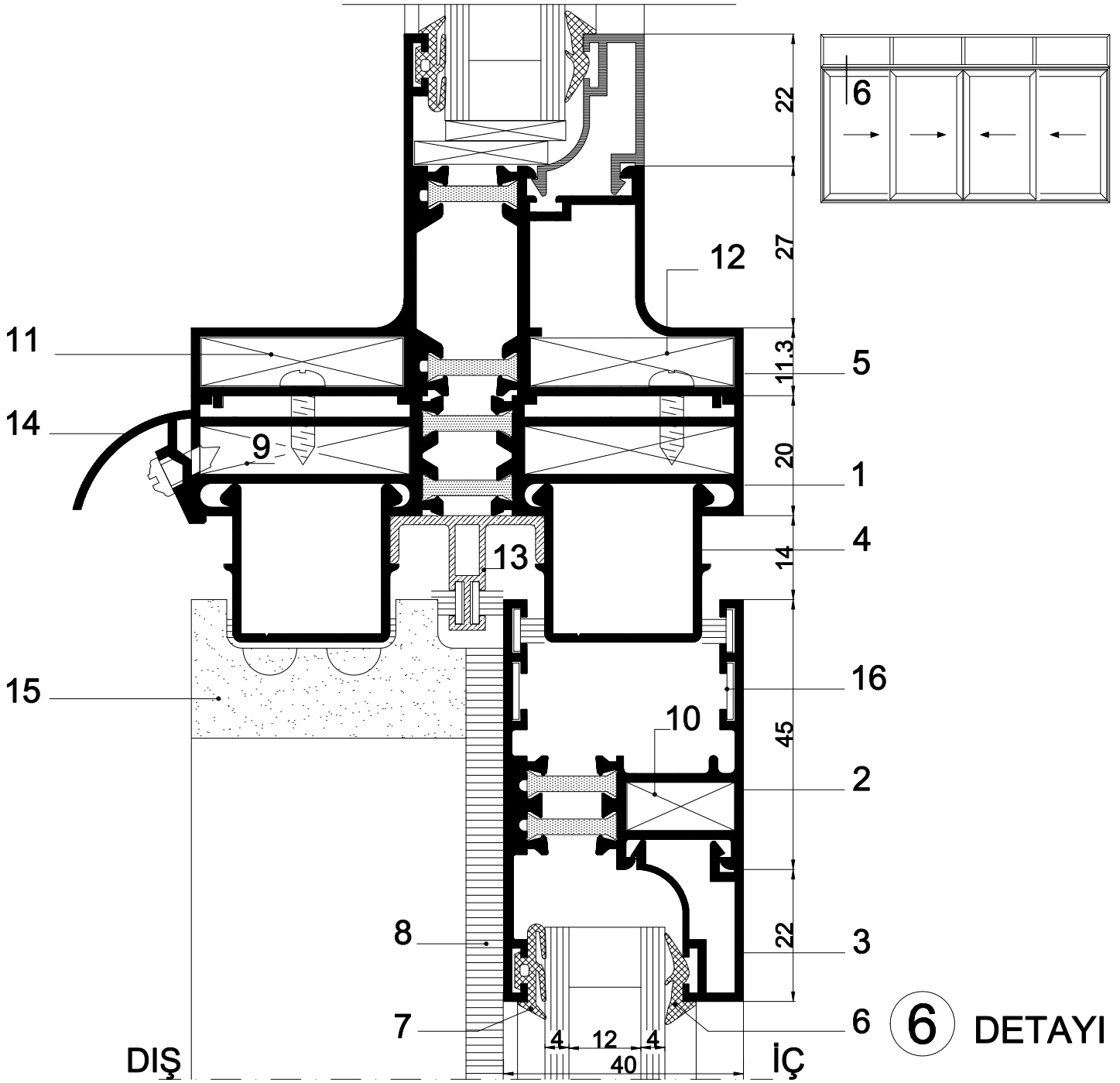
6 DETAYI

1. Kasa Profili	40 E 10	9. Köşe Takozu	97-922 (34.6 mm)
2. Kanat Profili	40 E 01	10. Köşe Takozu	97-922 (17.6 mm)
3. Cam Çıta Profili	40 E 70	11. Köşe Takozu	97-922 (33.6 mm)
4. Yan ve Üst Kasa Kapak Profili	40 E 82	12. Köşe Takozu	97-922 (33.6 mm)
5. E40 Sisteme Geçiş Profili	40 E 50	13. Toz Tutucu	40 D 12
6. İç Cam Fiteli	40 D 03	14. Damlalık Profili	40 E 86
7. Dış Cam Fiteli	40 D 02	15. Plastik Tapa	40 D 14
8. Fırça Fitol	40 D 04	16. Köşe Göyesi	40 D 21

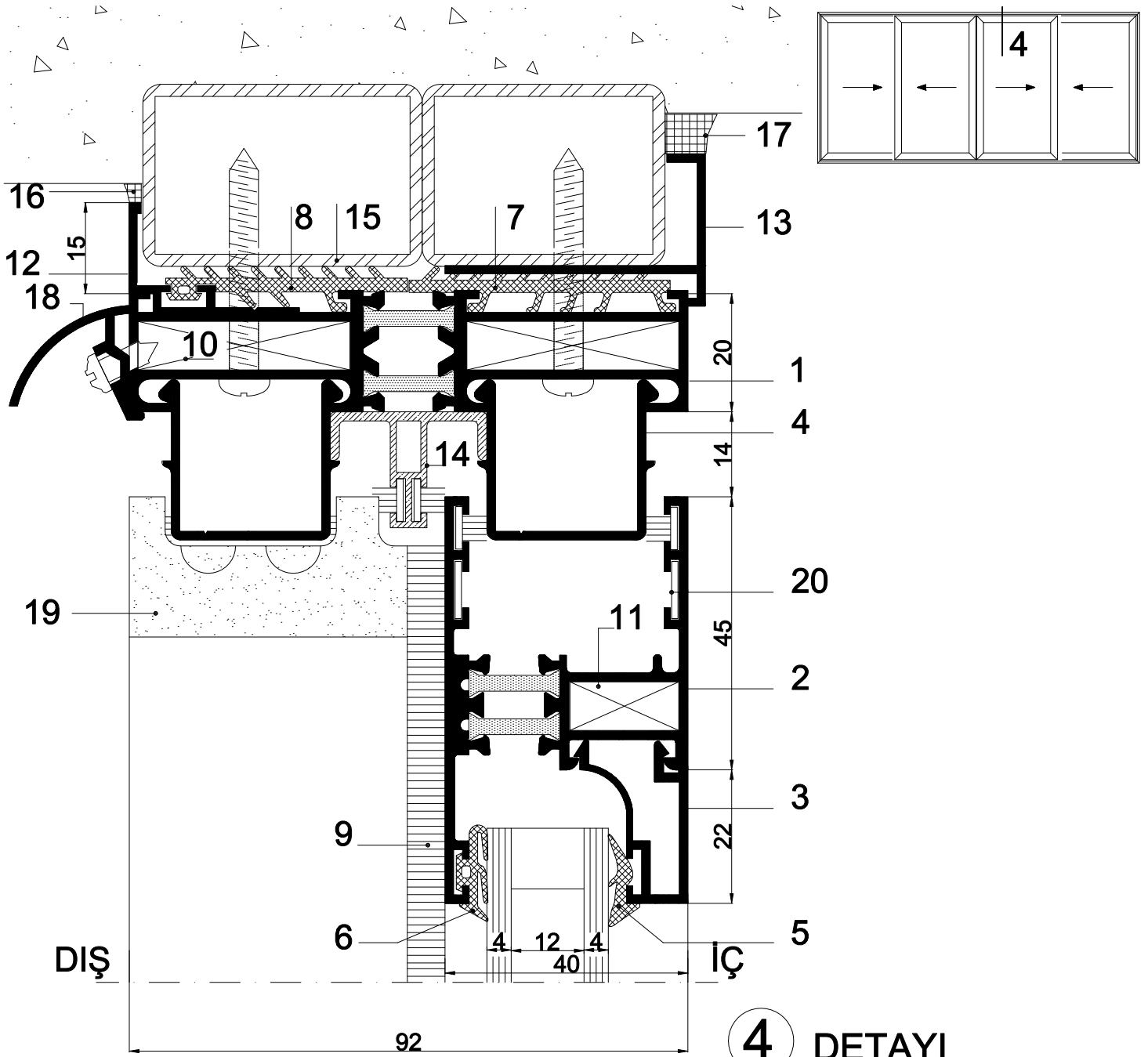
4 DETAYI

1. Kasa Profili	40 E 10	10. Köşe Takoğu	97-922 (34.6 mm)
2. Kanat Profili	40 E 01	11. Köşe Takoğu	97-922 (17.6 mm)
3. Cam Çıta Profili	40 E 70	12. İç Bini Profili	40 E 87
4. Yan ve Üst Kasa Kapak Profili	40 E 82	13. Dış Bini Profili	40 E 88
5. İç Cam Fıtılı	40 D 03	14. Toz Tutucu	40 D 12
6. Dış Cam Fıtılı	40 D 02	15. Körkasa	
7. Fıtıl	40 D 09	16. Silikon	
8. Fıtıl	40 D 10	17. 602 Çekomastik (Beyaz-Kahverengi-Siyah)	
9. Fırça Fıtıl	40 D 25	18. Damlalık Profili	40 E 86
		19. Plastik Tapa	40 D 14
		20. Köşe Gönyesi	40 D 21

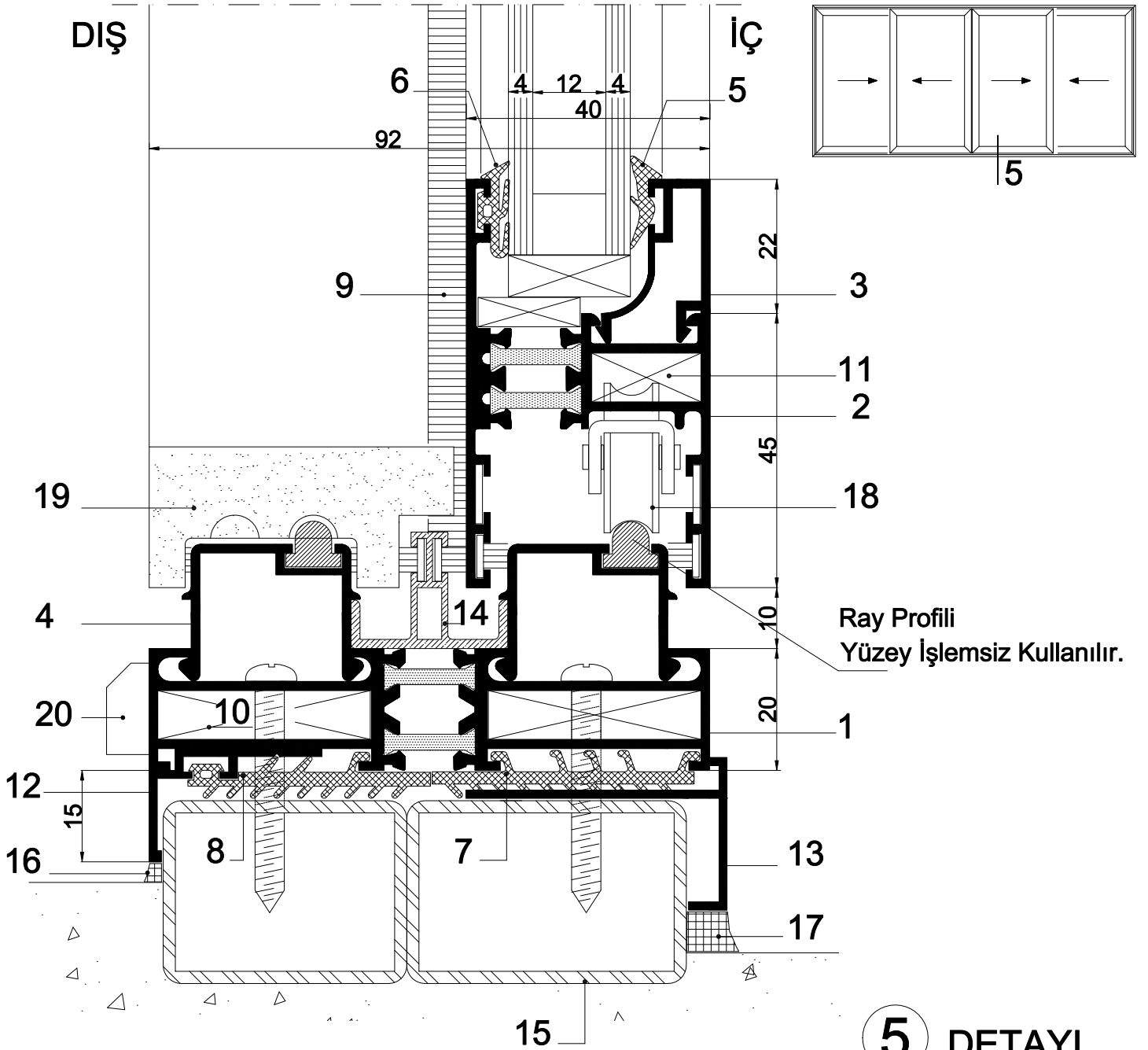
5 DETAYI

1. Kasa Profili	40 E 10	10. Köşe Takoğu	97-922 (34.6 mm)
2. Kanat Profili	40 E 01	11. Köşe Takoğu	97-922 (17.6 mm)
3. Cam Çıta Profili	40 E 70	12. İç Bini Profili	40 E 87
4. Alt Kasa Kapak Profili	40 E 81	13. Dış Bini Profili	40 E 88
5. İç Cam Fiteli	40 D 03	14. Toz Tutucu	40 D 12
6. Dış Cam Fiteli	40 D 02	15. Körkasa	
7. Fitol	40 D 09	16. Silikon	
8. Fitol	40 D 10	17. 602 Çekomastik (Beyaz-Kahverengi-Siyah)	
9. Fırça Fitol	40 D 25	18. Rulman	40 D 20
		19. Plastik Tapa	40 D 14
		20. Yağmur Tahliye Kapağı	40 D 13

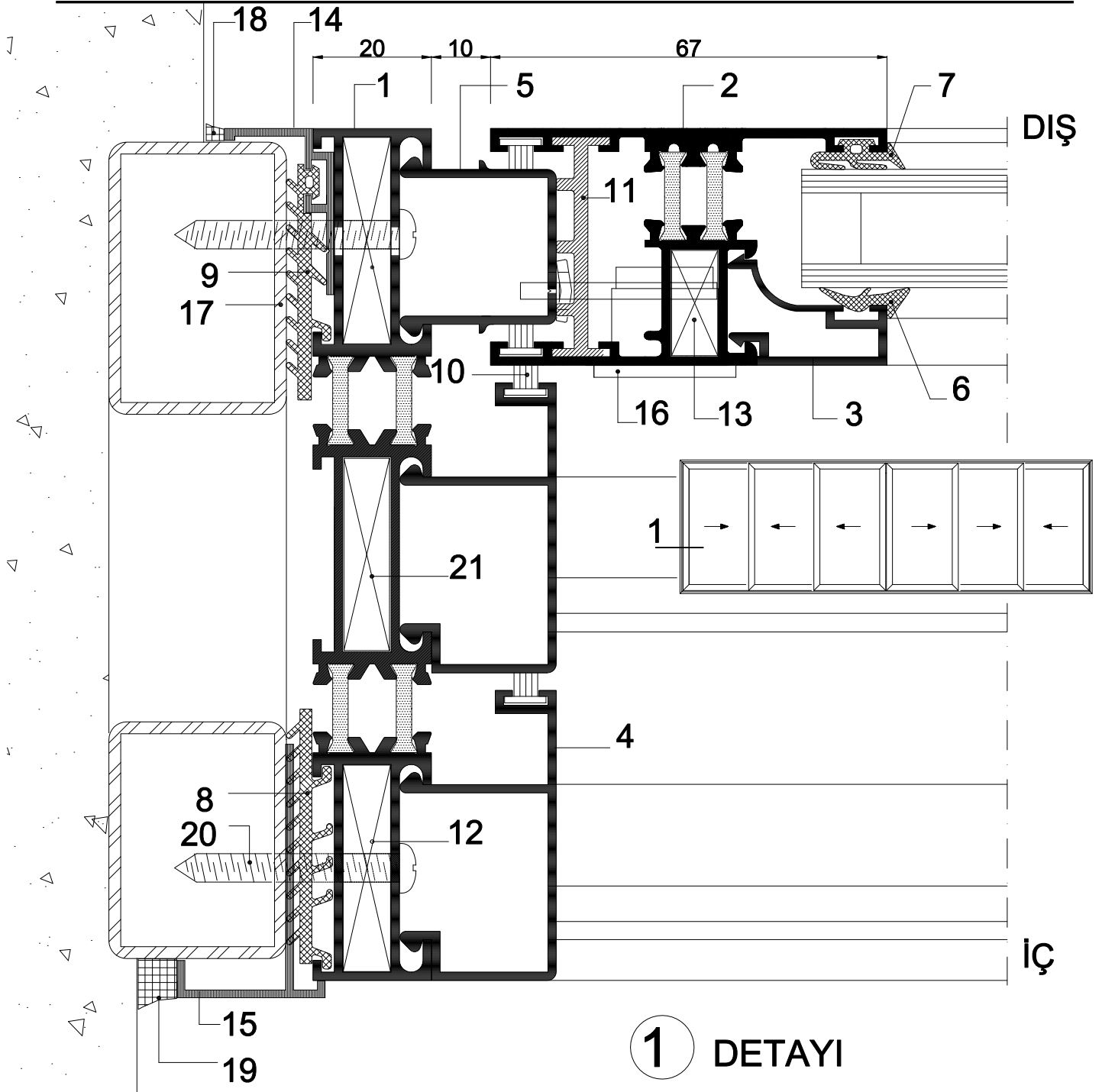

1. Kasa Profili	40 E 11	11. Sert Plastik Stoper 40 D 11	
2. Kanat Profili	40 E 01	12. Köşe Takoğu 97-922 (34.6 mm)	
3. Cam Çıta Profili	40 E 70	13. Köşe Takoğu 97-922 (17.6 mm)	
4. Yan Kasa Kapak Profili	40 E 83	14. İç Bini Profili 40 E 87	
5. Yan ve Üst Kasa Kapak Profili	40 E 82	15. Dış Bini Profili 40 E 88	
6. İç Cam Fitolu	40 D 03	16. Havuzlu Kilit 40 D 28	
7. Dış Cam Fitolu	40 D 02	17. Korkasa	
8. Fitolu	40 D 09	18. Silikon	
9. Fitolu	40 D 10	19. 602 Çekomastik (Beyaz-Kahverengi-Siyah)	
10. Fırça Fitolu	40 D 04	20. Vida 4.8x38 mm (Paslanmaz)	19
		21. Köşe Takoğu 97-922 (32.5 mm)	

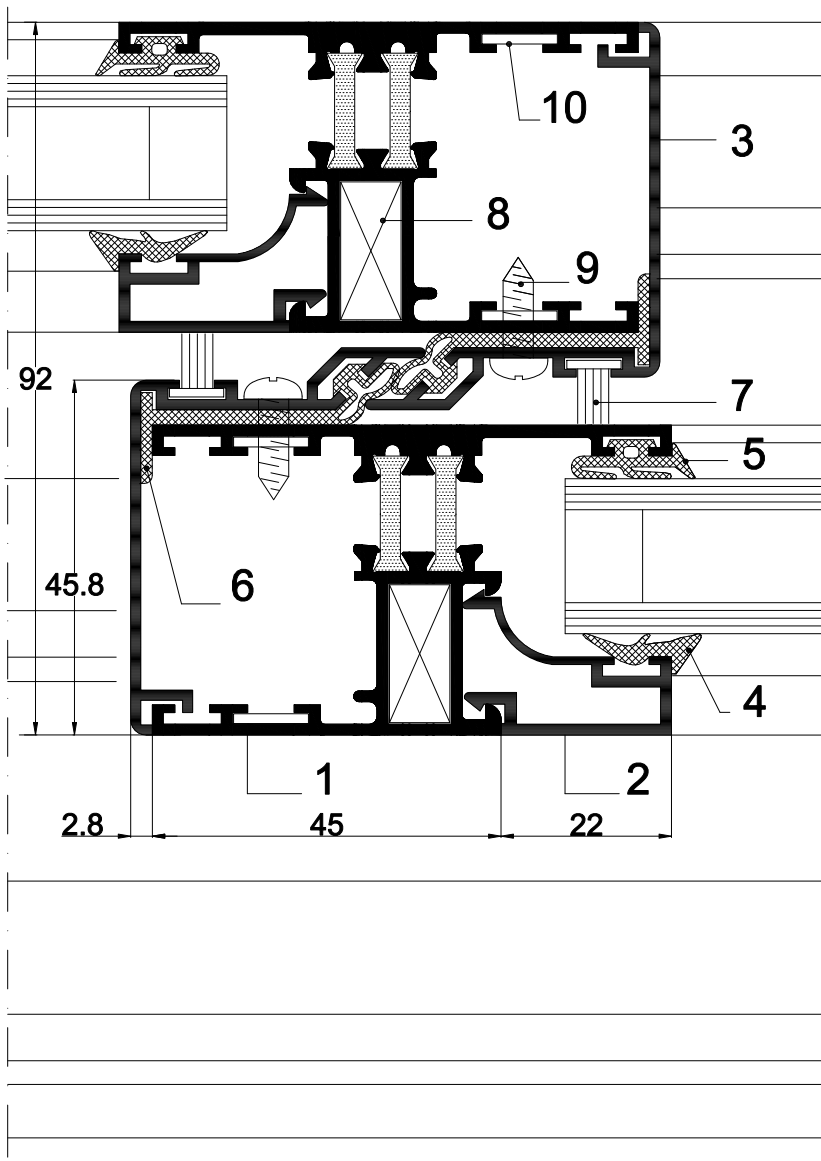

DIŞ

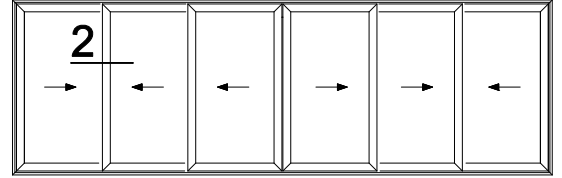

İÇ

2 DETAYI

1. Kanat Profili	40 E 01	6. Fitol	40 D 01
2. Cam Çita Profili	40 E 70	7. Fırça Fitol	40 D 25
3. Orta Kanat Bini Profili	40 E 84	8. Köşe Takoğu	97-922 (17.6 mm)
4. İç Cam Fitol	40 D 03	9. Vida 4.2x13 mm (Paslanmaz)	
5. Dış Cam Fitol	40 D 02	10. Köşe Gönyesi	40 D 21

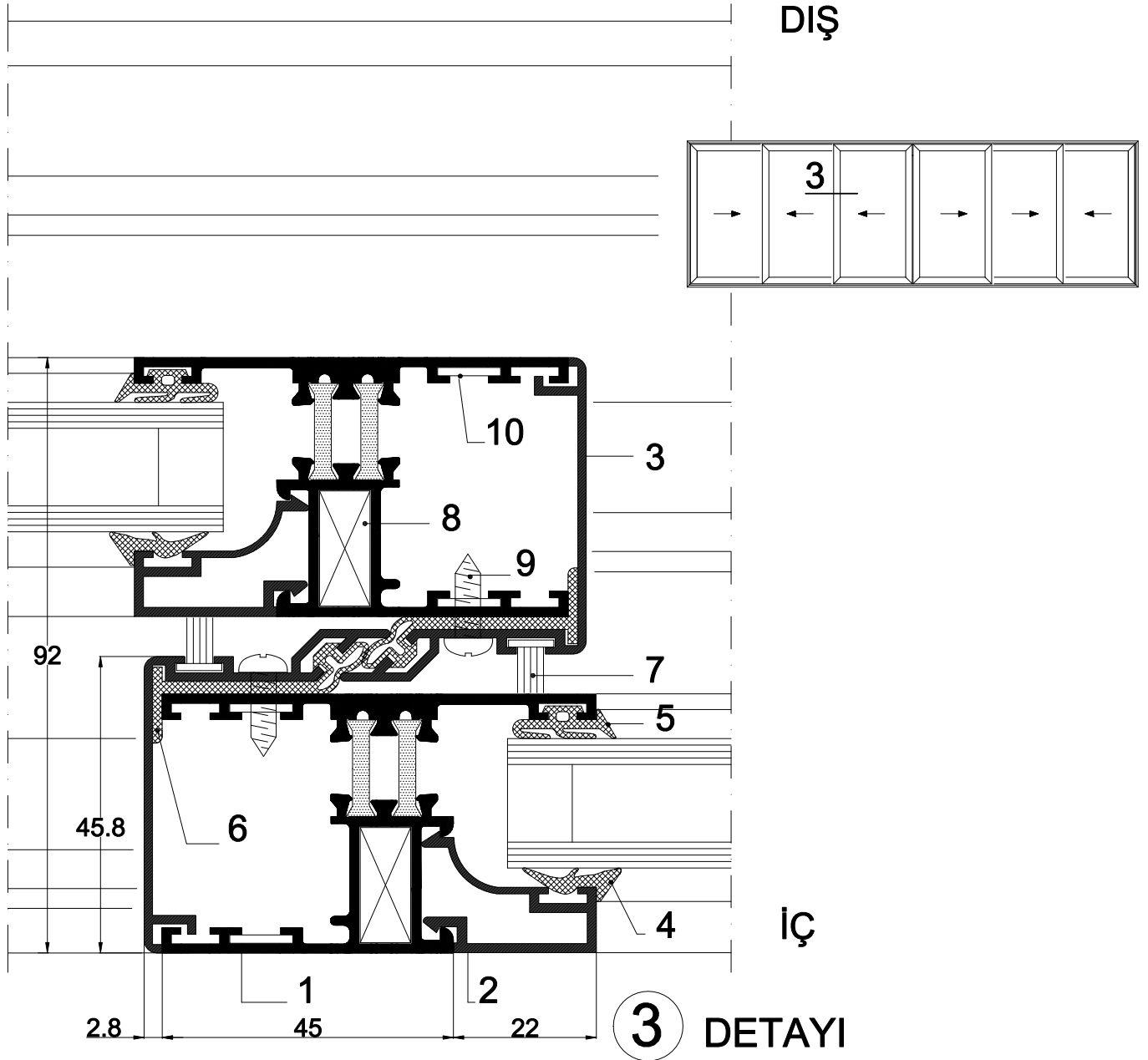

1. Kanat Profili	40 E 01	6. Fitol	40 D 01
2. Cam Çita Profili	40 E 70	7. Fırça Fitol	40 D 25
3. Orta Kanat Bini Profili	40 E 84	8. Köşe Takozu	97-922 (17.6 mm)
4. İç Cam Fitol	40 D 03	9. Vida 4.2x13 mm (Paslanmaz)	
5. Dış Cam Fitol	40 D 02	10. Köşe Gönyesi	40 D 21

DIŞ

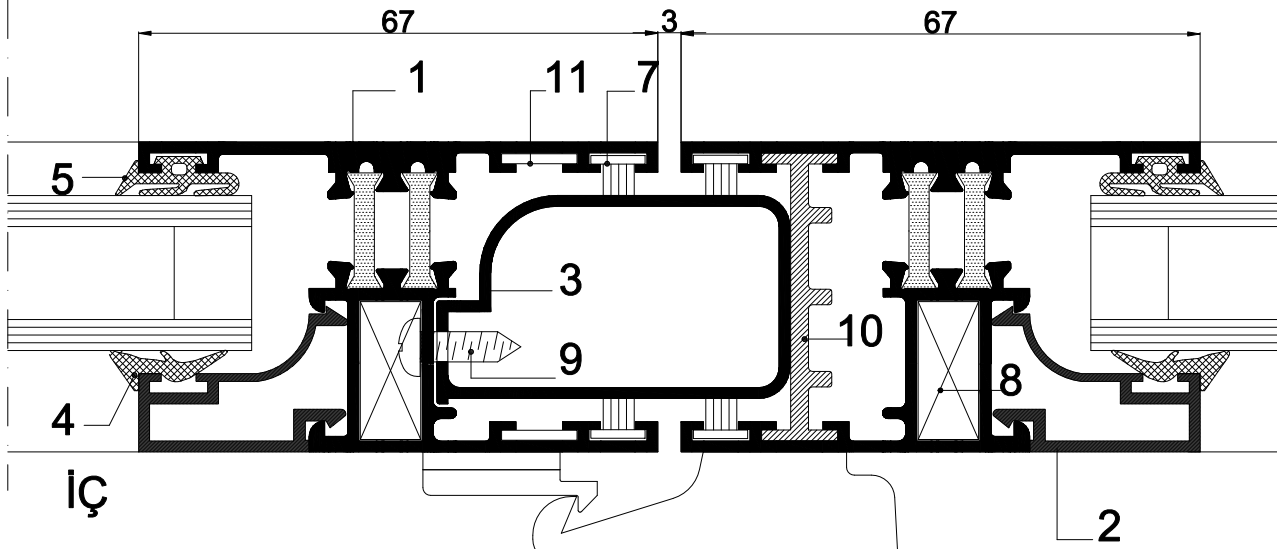
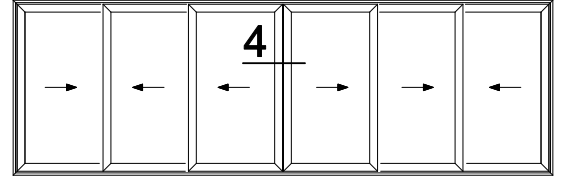

4 DETAYI

- | | | | |
|----------------------------|---------|-------------------------------|-------------------|
| 1. Kanat Profili | 40 E 01 | 6. Klepsli Kilit | 40 D 16 - 40 D 17 |
| 2. Cam Çita Profili | 40 E 70 | 7. Fırça Fitali | 40 D 04 |
| 3. Orta Kanat Bini Profili | 40 E 85 | 8. Köşe Takoğu | 97-922 (17.6 mm) |
| 4. İç Cam Fitali | 40 D 03 | 9. Vida 4.2x13 mm (Paslanmaz) | |
| 5. Dış Cam Fitali | 40 D 02 | 10. Sert Plastik Stoper | 40 D 11 |
| | | 11. Köşe Gönyesi | 40 D 21 |

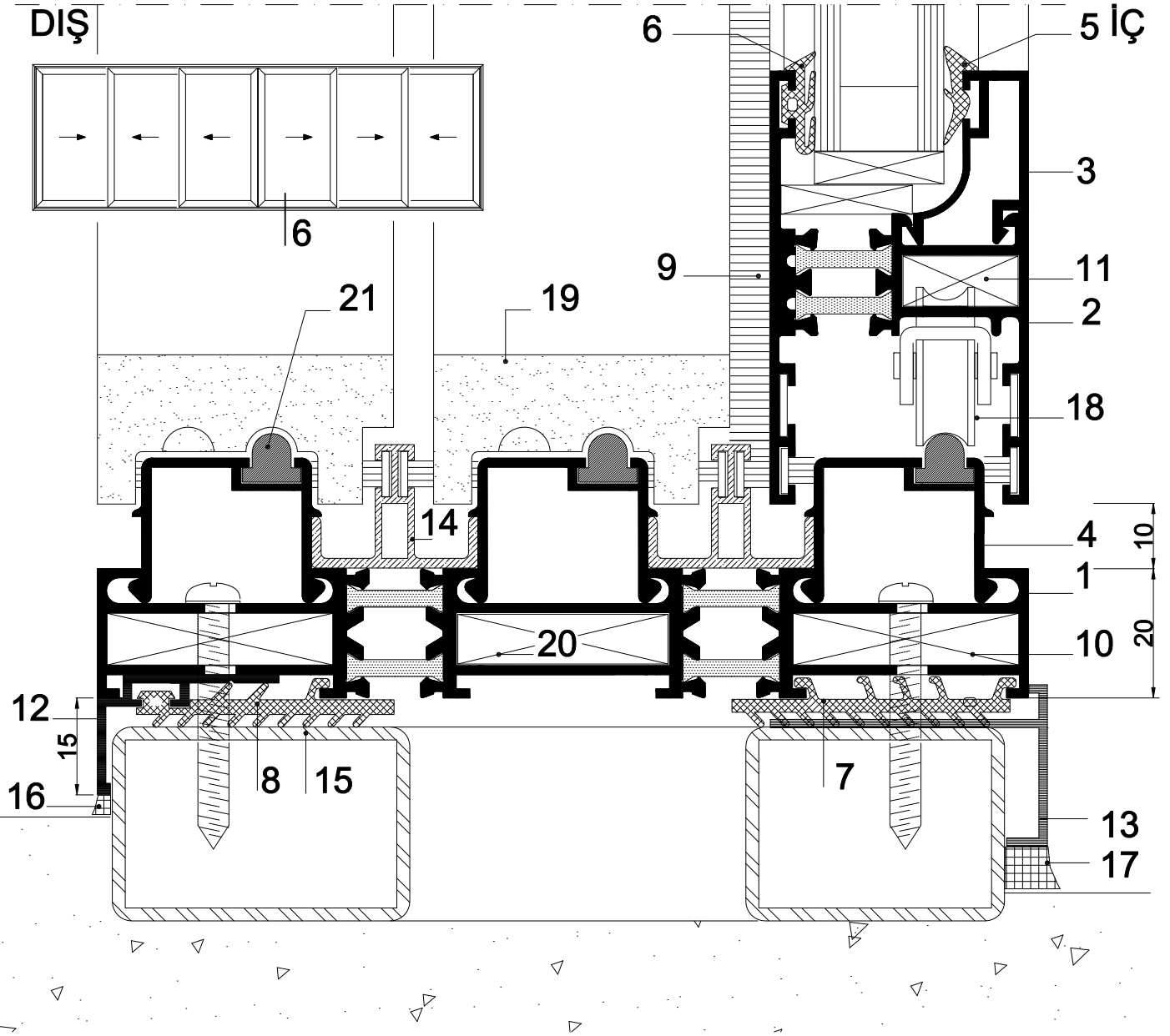

6 DETAYI

1. Kasa Profili	40 E 11	10. Köşe Takozu	97-922 (34.6 mm)
2. Kanat Profili	40 E 01	11. Köşe Takozu	97-922 (17.6 mm)
3. Cam Çita Profili	40 E 70	12. İç Bini Profili	40 E 87
4. Alt Kasa Kapak Profili	40 E 81	13. Dış Bini Profili	40 E 88
5. İç Cam Fiteli	40 D 03	14. Toz Tutucu	40 D 12
6. Dış Cam Fiteli	40 D 02	15. Körkasa	
7. Fitol	40 D 09	16. Silikon	
8. Fitol	40 D 10	17. 602 Çekomastik (Beyaz-Kahverengi-Siyah)	
9. Fırça Fitol	40 D 25	18. Rulman	40 D 20
		19. Plastik Tapa	40 D 14
		20. Köşe Takozu	97-922 (32.5 mm)

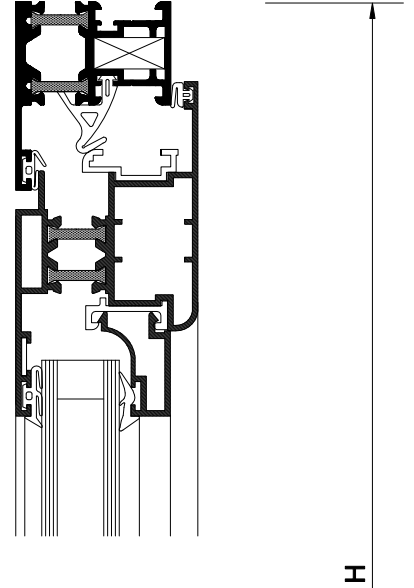
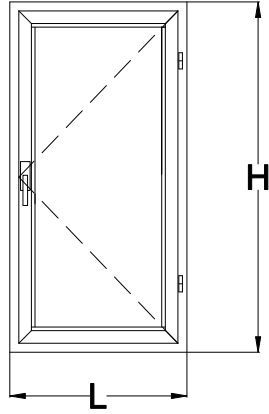

Profil	Ad.	Kesim Ölçüsü	Kesim Açısı
40 E 20	2	H	45° x 45°
40 E 20	2	L	45° x 45°
40 E 30	2	H - 41,4	45° x 45°
40 E 30	2	L - 41,4	45° x 45°
40 E 70	2	L - 170,2	90° x 90°
40 E 70	2	H - 214,2	90° x 90°

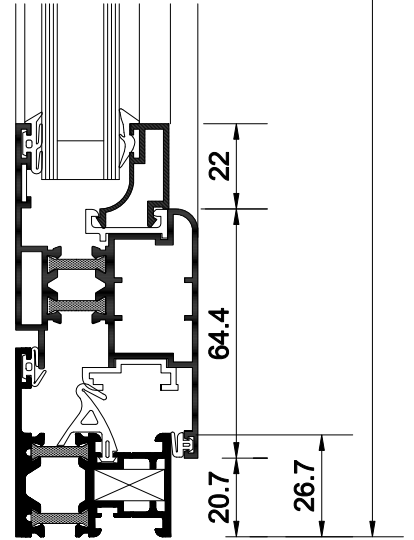

NOT: 40 E 60 ve 40 E 61 Doğramanın üzerinden ölçü alınarak kesilecektir.

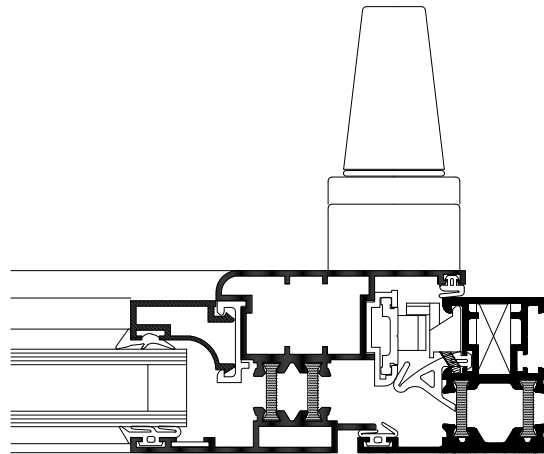
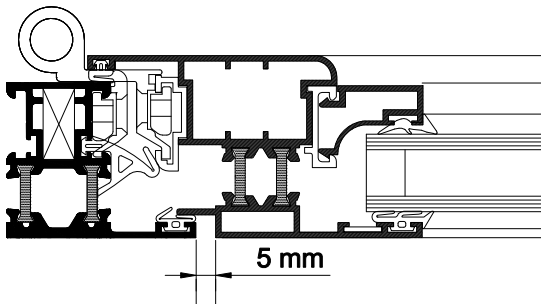

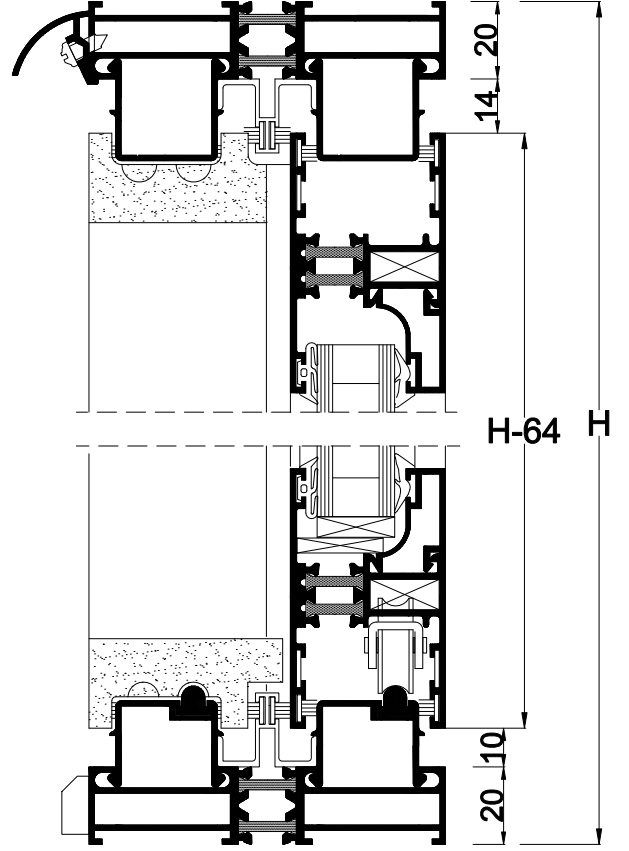
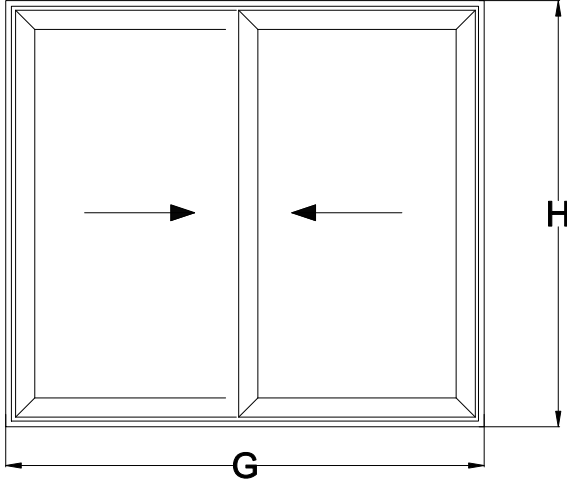

PROFİL	Ad.	KESİM ÖLÇÜSÜ (mm)	KESİM AÇISI
40 E 10	2	H	45° x 45°
40 E 10	2	G	45° x 45°
40 E 01	4	H - 64	45° x 45°
40 E 01	4	G/2 + 3.5	45° x 45°
40 E 84	2	H - 110	90° x 90°
40 E 83	2	H - 40	90° x 90°
40 E 82	2	G - 82	90° x 90°
40 E 82	2	H - 40	90° x 90°
40 E 81	2	G - 82	90° x 90°
40 E 70	4	H - 198	90° x 90°
40 E 70	4	G/2 - 86.5	90° x 90°
40 E 80	2	G - 82	90° x 90°

