

Dışa Açılan Kapı

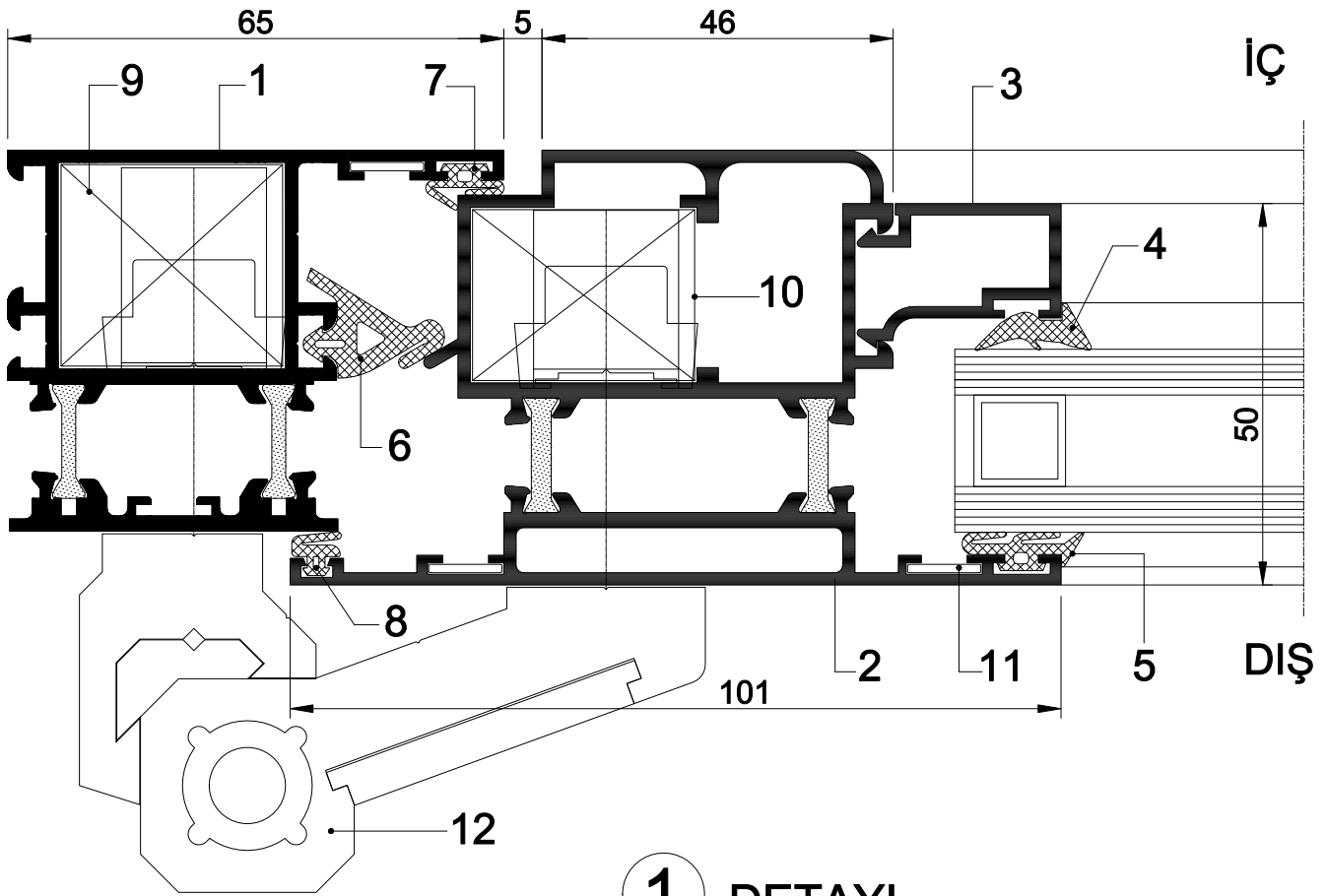

1 DETAYI

| | | | |
|----------------------------------|---------|-------------------------|---------|
| 1. Dışa Açılan Kapı Kasa Profili | 50 E 39 | 7. Dış bini fitili | 40 D 08 |
| 2. Kanat Profili | 50 E 30 | 8. İç bini fitili | 40 D 06 |
| 3. Cam Çıta Profili | 40 E 73 | 9. Köşe Takoğu | 99-1151 |
| 4. İç Cam Fitili | 40 D 03 | 10. Köşe Takoğu | 99-1151 |
| 5. Dış Cam Fitili | 40 D 02 | 11. Köşe Gönyesi | 40 D 21 |
| 6. Kasa Takoz Fitili | 50 D 23 | 12. Dışa açılan menteşe | |

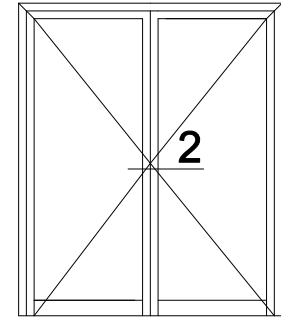
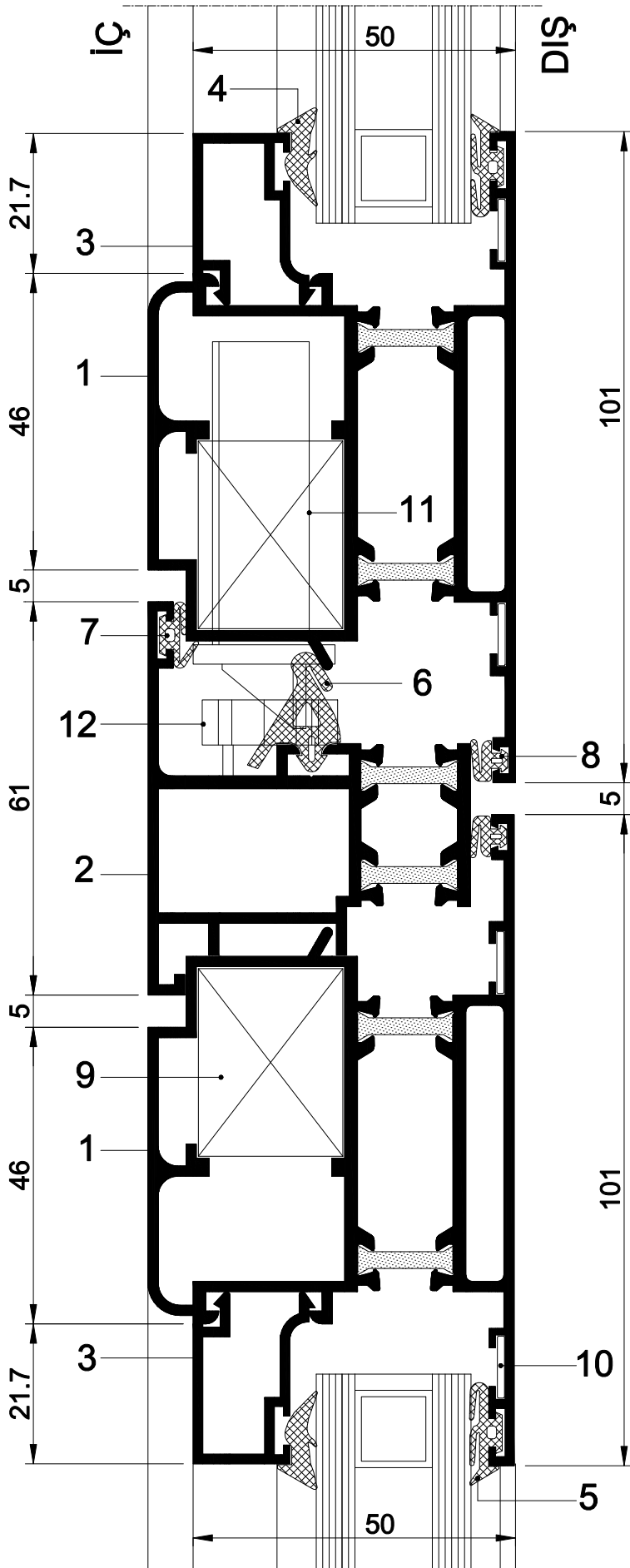

Dışa Açılan Kapı

2 DETAYI

| | |
|----------------------|---------|
| 1. Kanat Profili | 50 E 30 |
| 2. Adaptör Profili | 50 E 31 |
| 3. Cam Çıta Profili | 40 E 73 |
| 4. İç Cam Fiteli | 40 D 03 |
| 5. Dış Cam Fiteli | 40 D 02 |
| 6. Kasa Takoz Fiteli | 50 D 23 |
| 7. Dış bini fitili | 40 D 08 |
| 8. İç bini fitili | 40 D 06 |
| 9. Köşe Takozu | 99-1151 |
| 10. Köşe Gönyesi | 40 D 21 |
| 11. Kilit | |
| 12. Kilit Karşılığı | 50 E 98 |

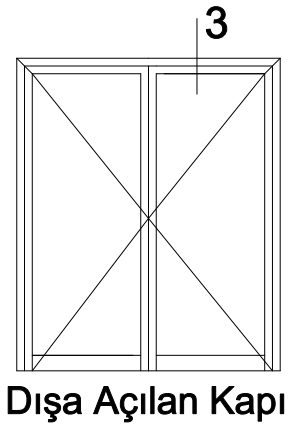
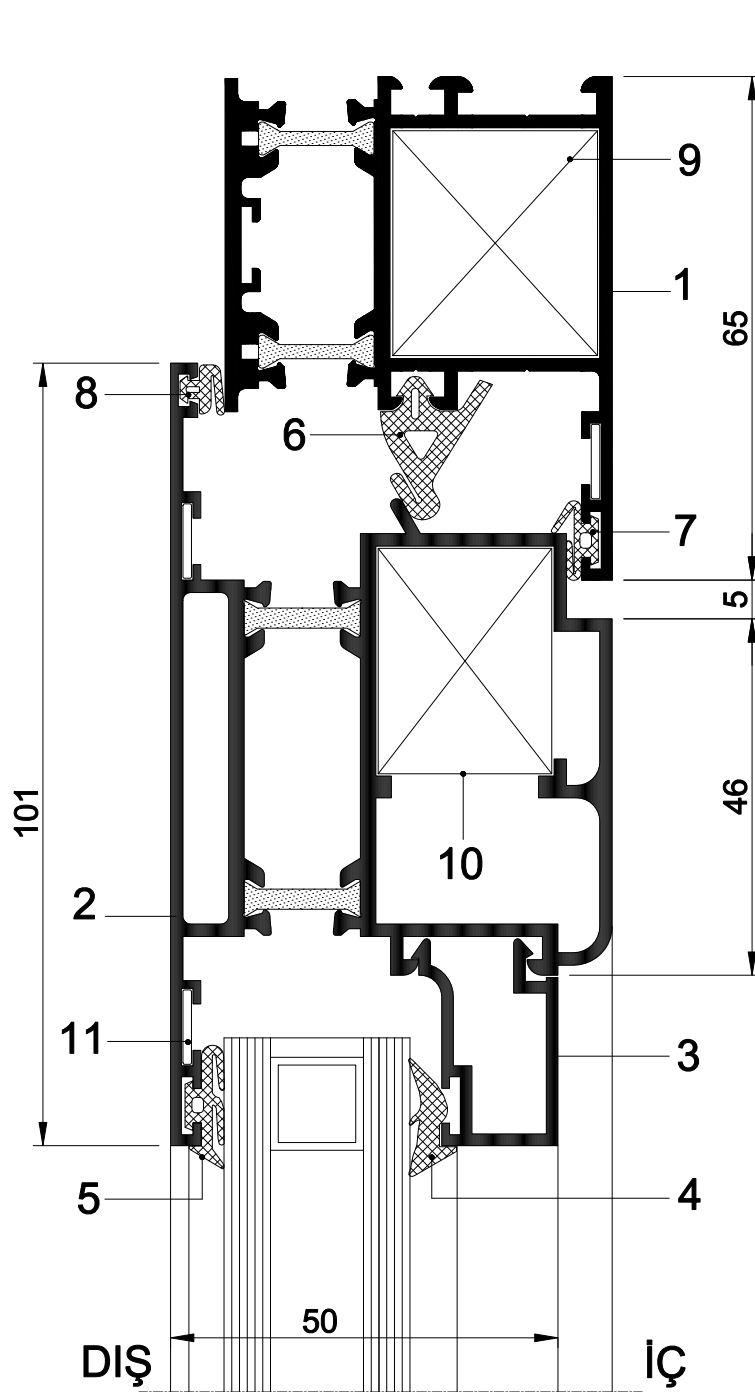

3 DETAYI

| | | | |
|----------------------------------|---------|--------------------|---------|
| 1. Dışa Açılan Kapı Kasa Profili | 50 E 39 | 7. Dış bini fitili | 40 D 08 |
| 2. Kanat Profili | 50 E 30 | 8. İç bini fitili | 40 D 06 |
| 3. Cam Çıta Profili | 40 E 73 | 9. Köşe Takozu | 99-1151 |
| 4. İç Cam Fitili | 40 D 03 | 10. Köşe Takozu | 99-1151 |
| 5. Dış Cam Fitili | 40 D 02 | 11. Köşe Gönyesi | 40 D 21 |
| 6. Kasa Takoz Fitili | 50 D 23 | | |

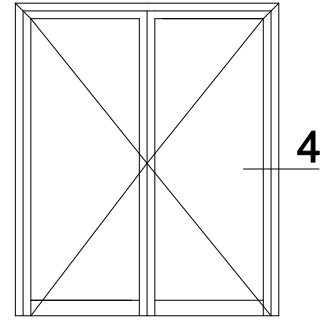

Dışa Açılan Kapı

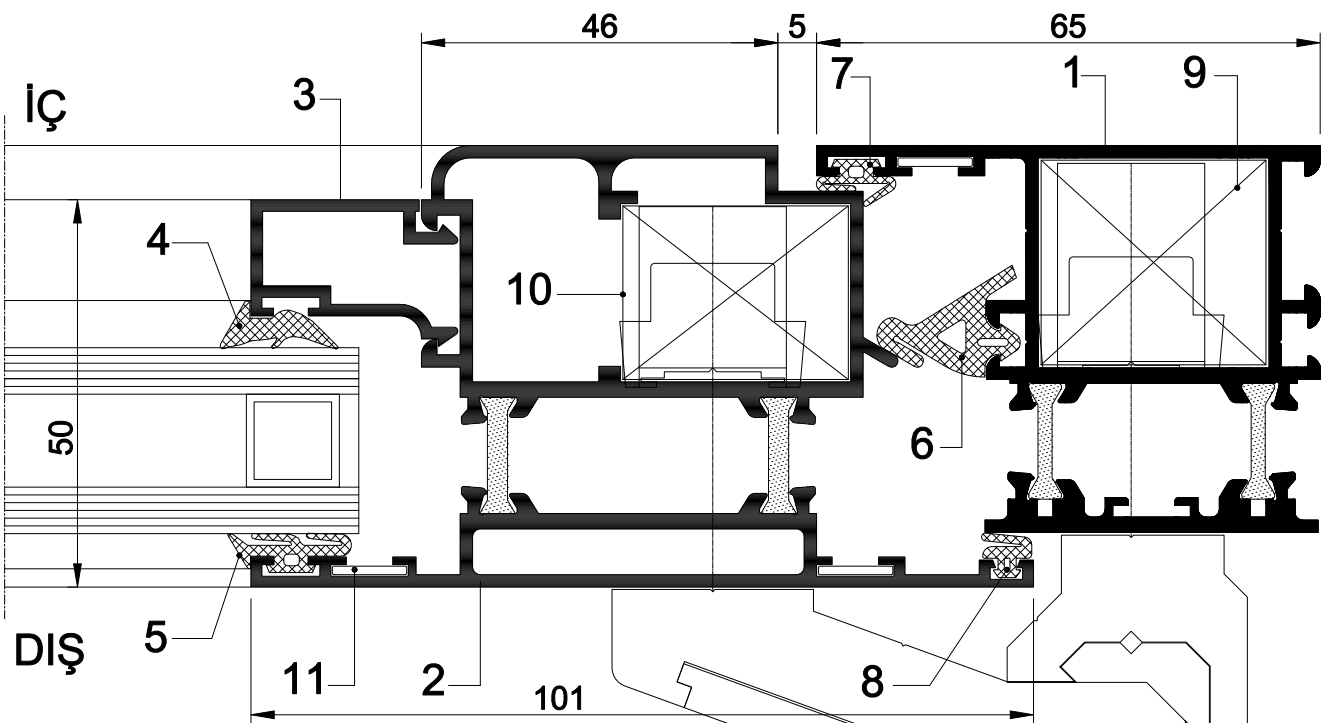

4 DETAYI

| | | | |
|----------------------------------|---------|-------------------------|---------|
| 1. Dışa Açılan Kapı Kasa Profili | 50 E 39 | 7. Dış bini fitili | 40 D 08 |
| 2. Kanat Profili | 50 E 30 | 8. İç bini fitili | 40 D 06 |
| 3. Cam Çıta Profili | 40 E 73 | 9. Köşe Takozu | 99-1151 |
| 4. İç Cam Fitili | 40 D 03 | 10. Köşe Takozu | 99-1151 |
| 5. Dış Cam Fitili | 40 D 02 | 11. Köşe Gönyesi | 40 D 21 |
| 6. Kasa Takoz Fitili | 50 D 23 | 12. Dışa açılan menteşe | |