

50 E 26

AĞIRLIK : 1.197 kg/mt.

JX: 12.06 cm⁴

JY: 4.68 cm⁴

43

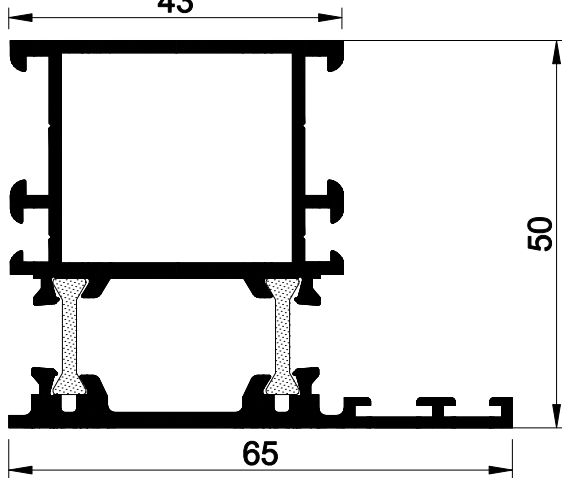

50 E 25

AĞIRLIK : 1.458 kg/mt.

JX: 15.56 cm⁴

JY: 13.88 cm⁴

65

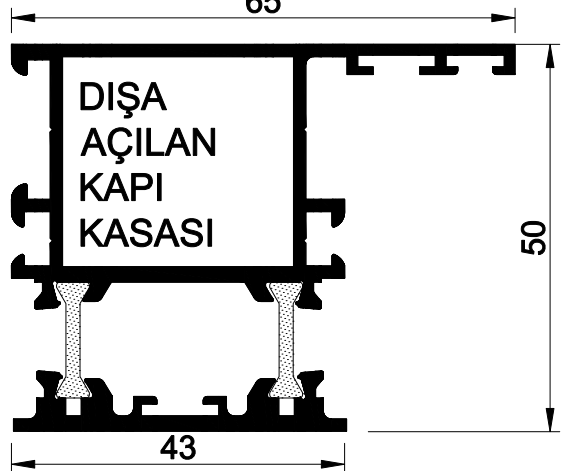

50 E 39

AĞIRLIK : 1.464 kg/mt.

JX: 16.64 cm⁴

JY: 13.70 cm⁴

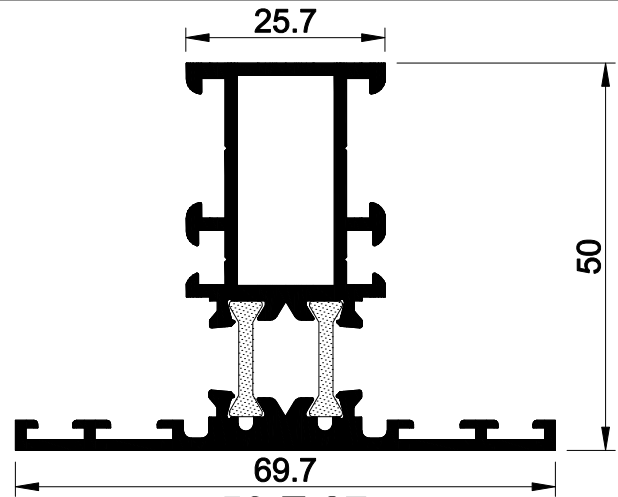

50 E 27

AĞIRLIK : 1.328 kg/mt.

JX: 13.60 cm⁴

JY: 7.99 cm⁴

43

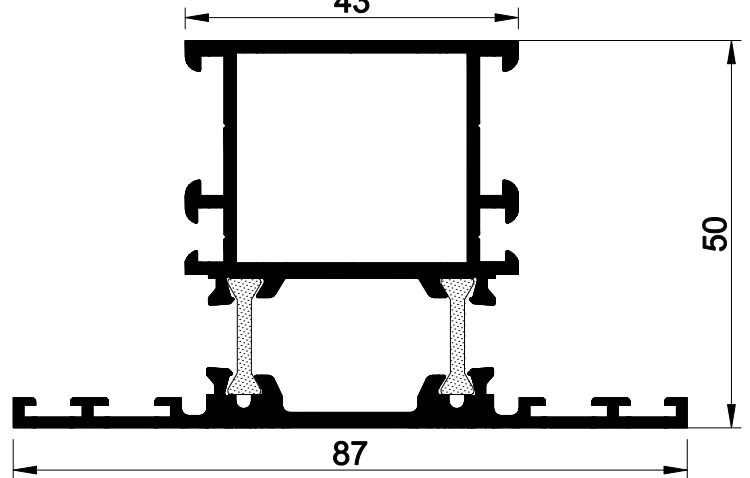

50 E 38

AĞIRLIK : 1.589 kg/mt.

JX: 17.26 cm⁴

JY: 19.82 cm⁴

65

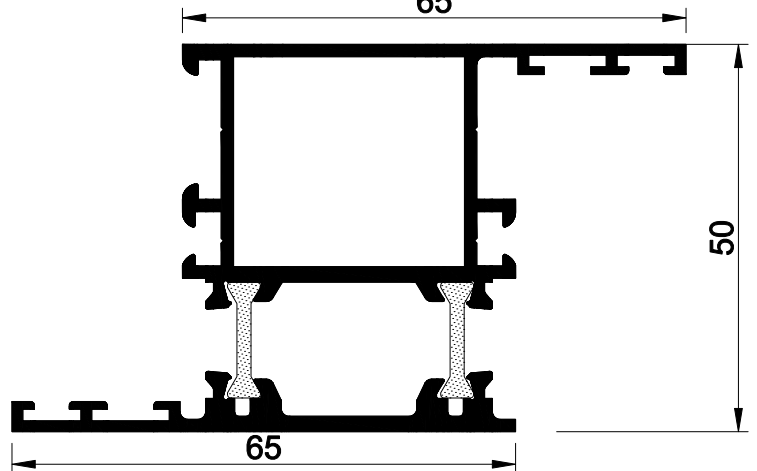

50 E 61

AĞIRLIK : 1.567 kg/mt.

JX: 18.66 cm⁴

JY: 19.43 cm⁴

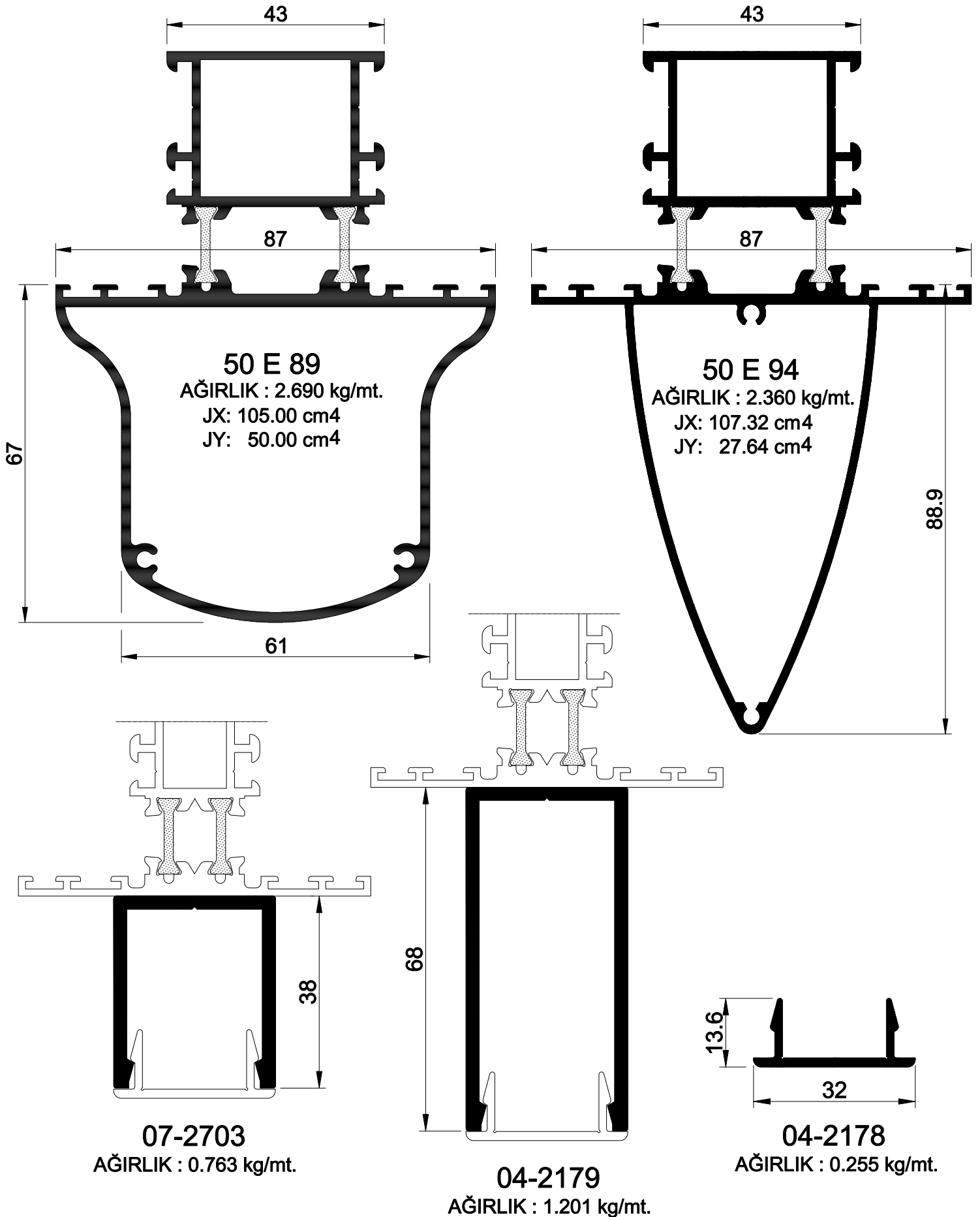

DE 50

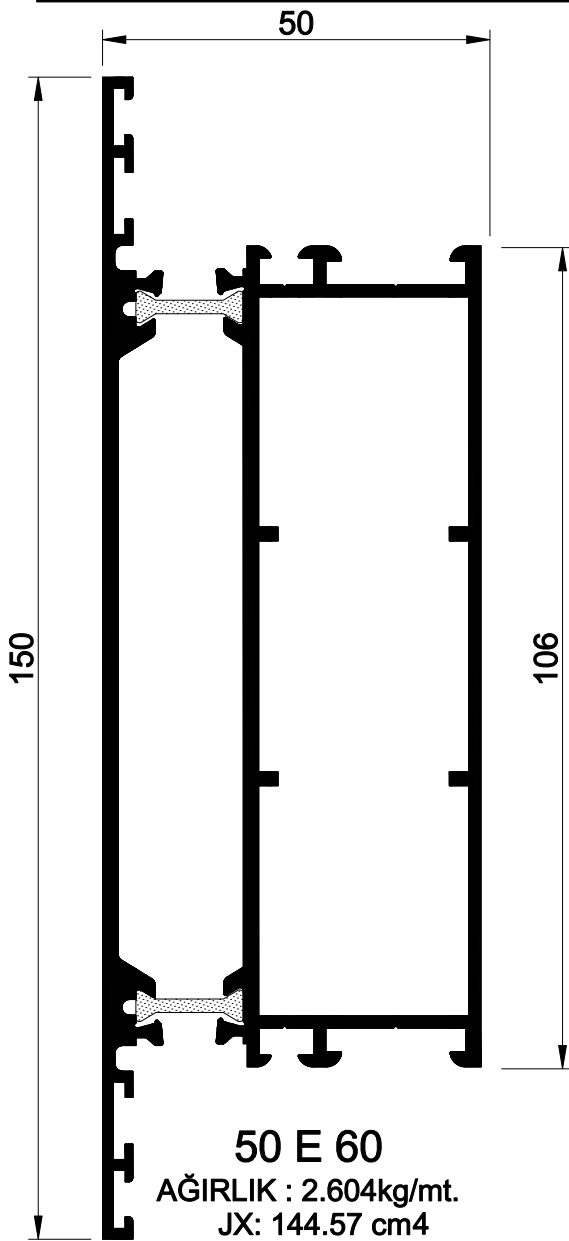

50 E 60
AĞIRLIK : 2.604kg/mt.
JX: 144.57 cm⁴
JY: 29.72 cm⁴

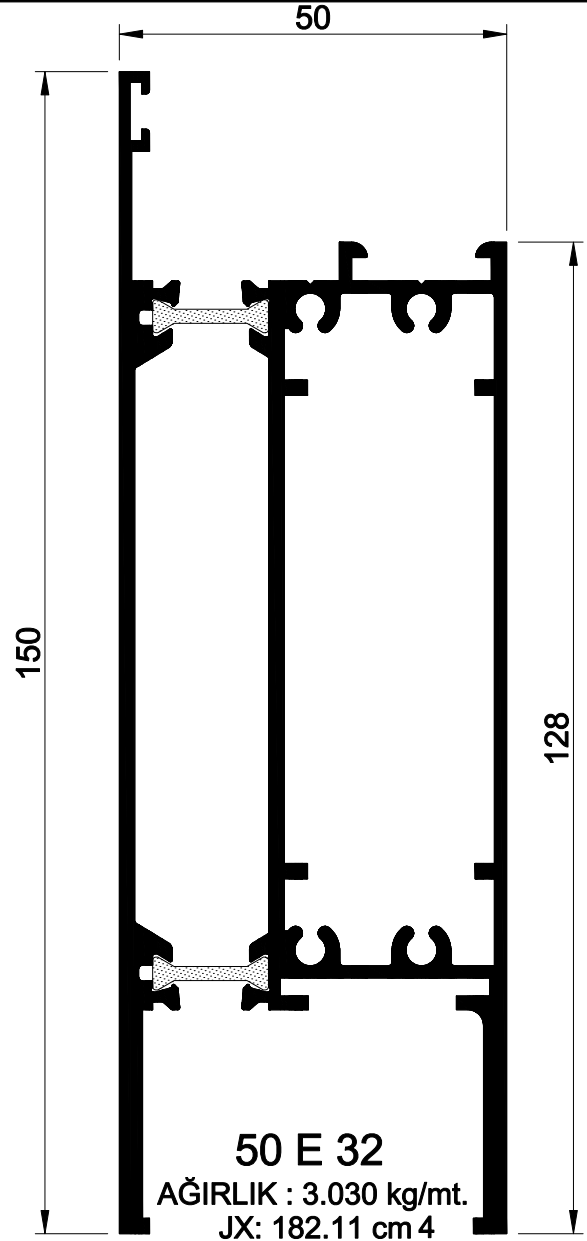

50 E 32
AĞIRLIK : 3.030 kg/mt.
JX: 182.11 cm⁴
JY: 39.36 cm⁴

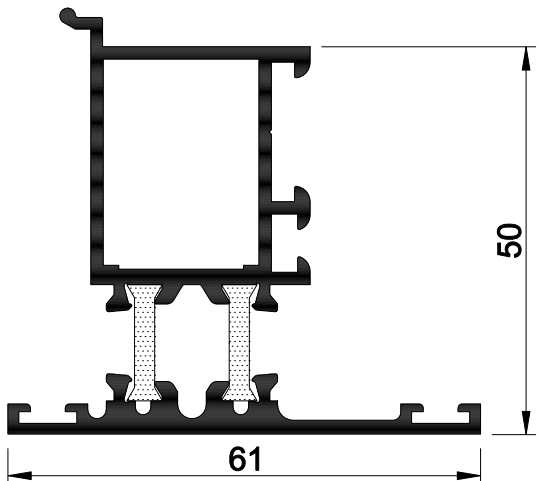

50 E 33
AĞIRLIK : 1.291 kg/mt.
JX: 13.70 cm⁴
JY: 7.53 cm⁴

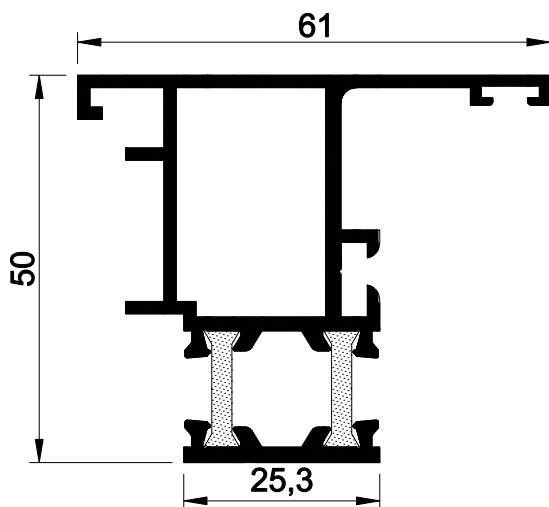

50 E 31
AĞIRLIK : 1.187 kg/mt.
JX: 12.61 cm⁴
JY: 7.30 cm⁴

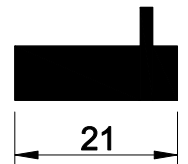

50 E 98
AĞIRLIK : 0.420 kg/mt.



88-033
AĞIRLIK : 0.130 kg/mt.

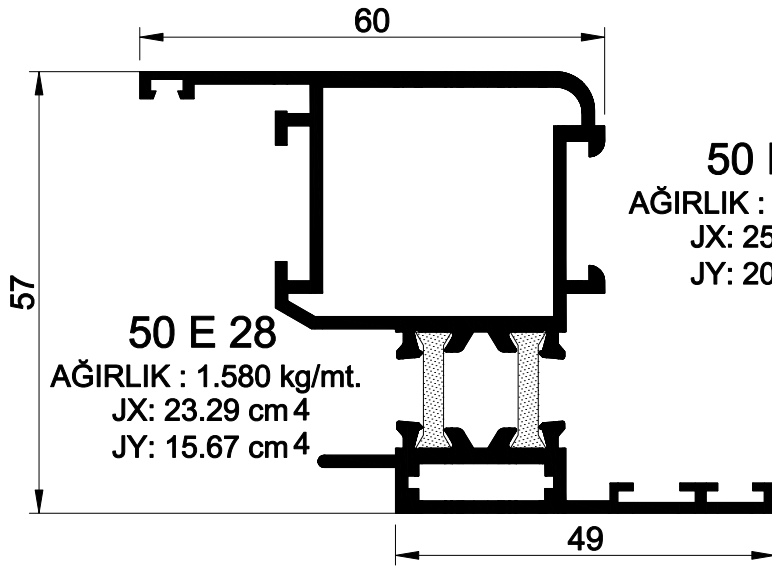

50 E 63
AĞIRLIK : 1.767 kg/mt.
JX: 25.95 cm⁴
JY: 20.47 cm⁴

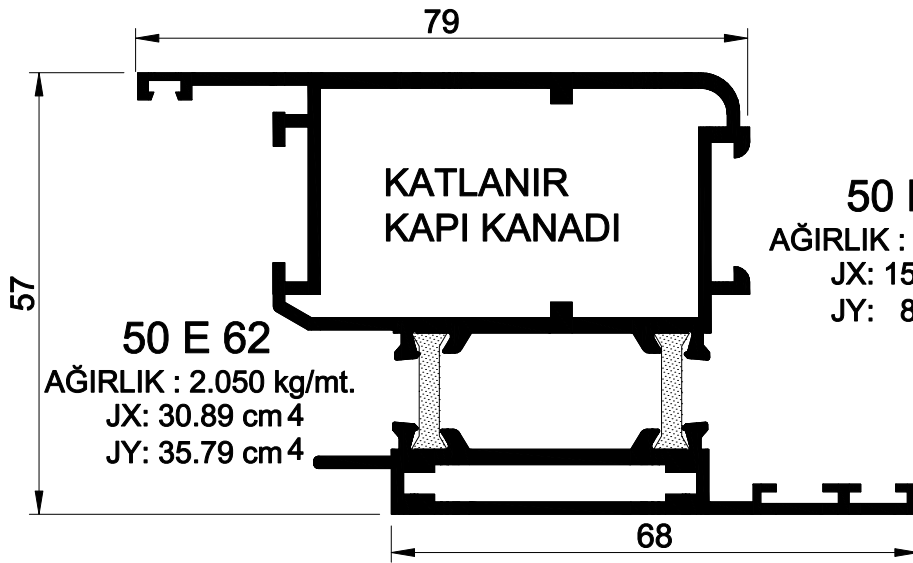
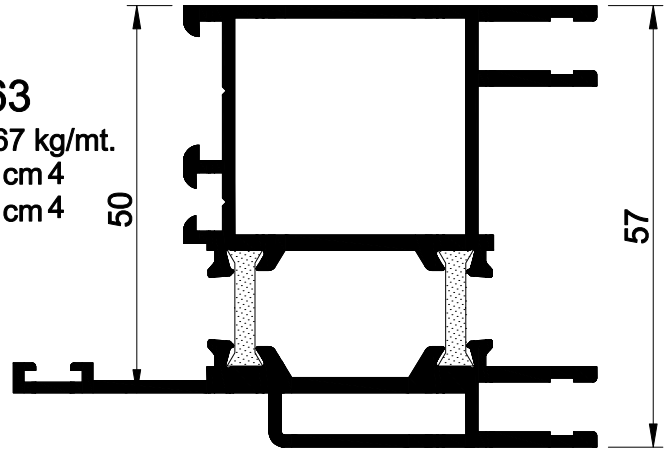

50 E 150
AĞIRLIK : 1.194 kg/mt.
JX: 15.07 cm⁴
JY: 8.03 cm⁴

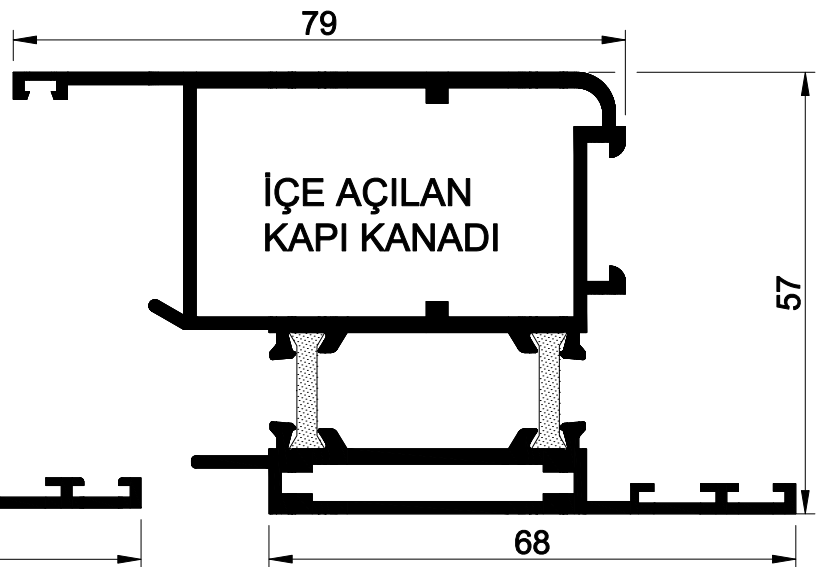
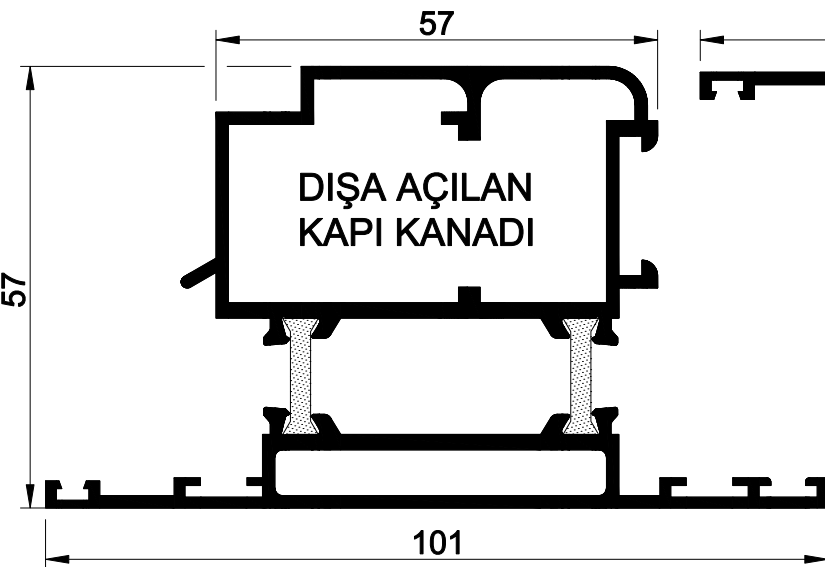
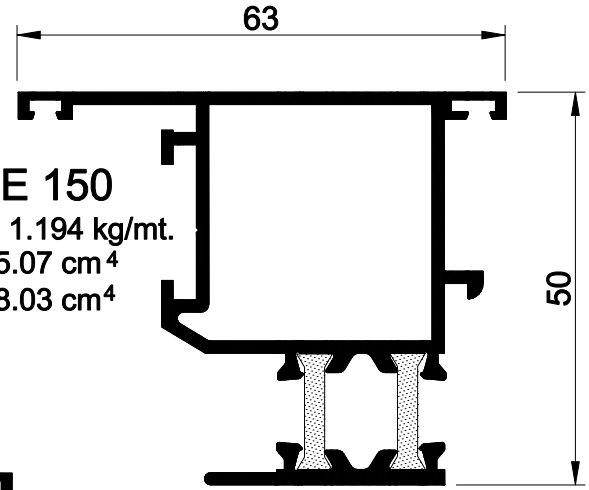

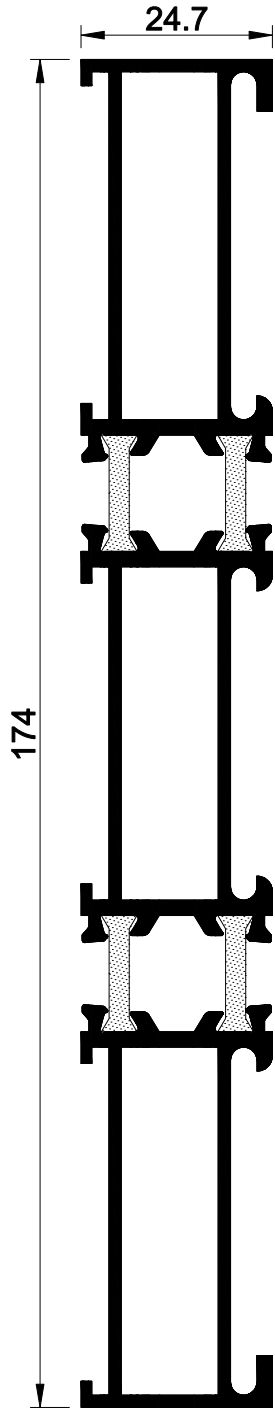

50 E 37
 AĞIRLIK : 2.352 kg/mt.
 JX: 234.60 cm⁴
 JY: 5.18 cm⁴

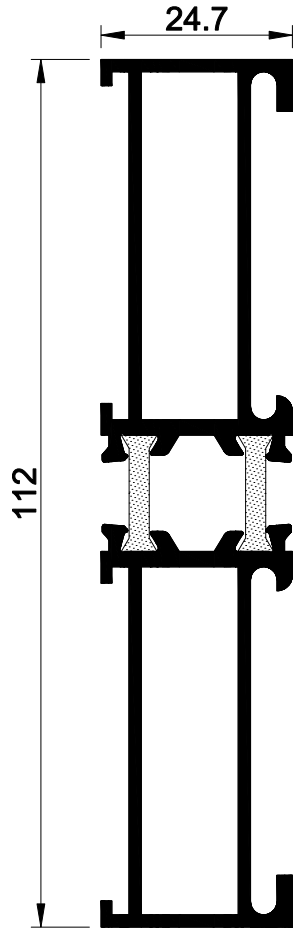

50 E 34
 AĞIRLIK : 1.623 kg/mt.
 JX: 67.06 cm⁴
 JY: 3.33 cm⁴

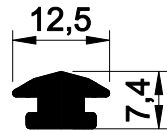

05-2306
 AĞIRLIK : 0.160 kg/mt

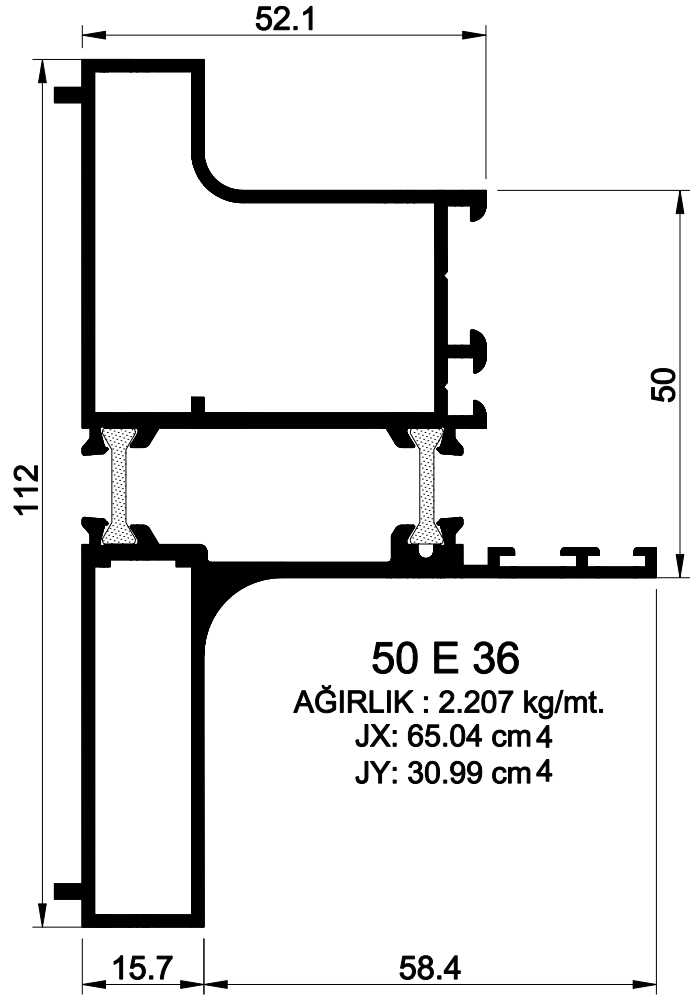

50 E 36
 AĞIRLIK : 2.207 kg/mt.
 JX: 65.04 cm⁴
 JY: 30.99 cm⁴

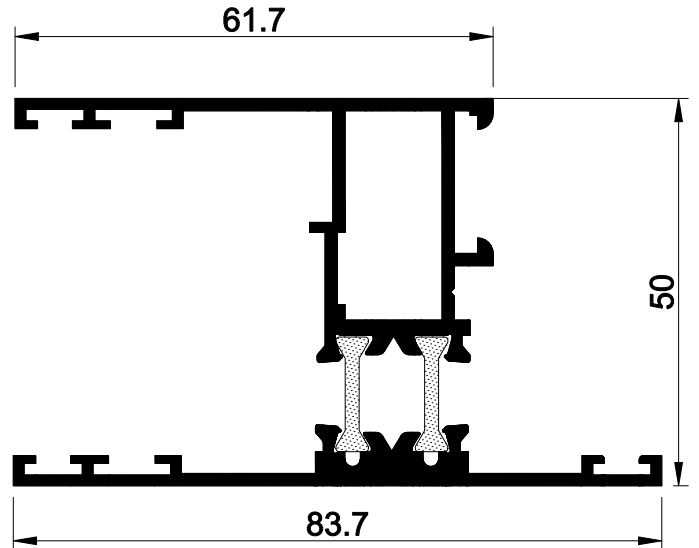

50 E 35
 AĞIRLIK : 1.484 kg/mt.
 JX: 19.69 cm⁴
 JY: 18.47 cm⁴

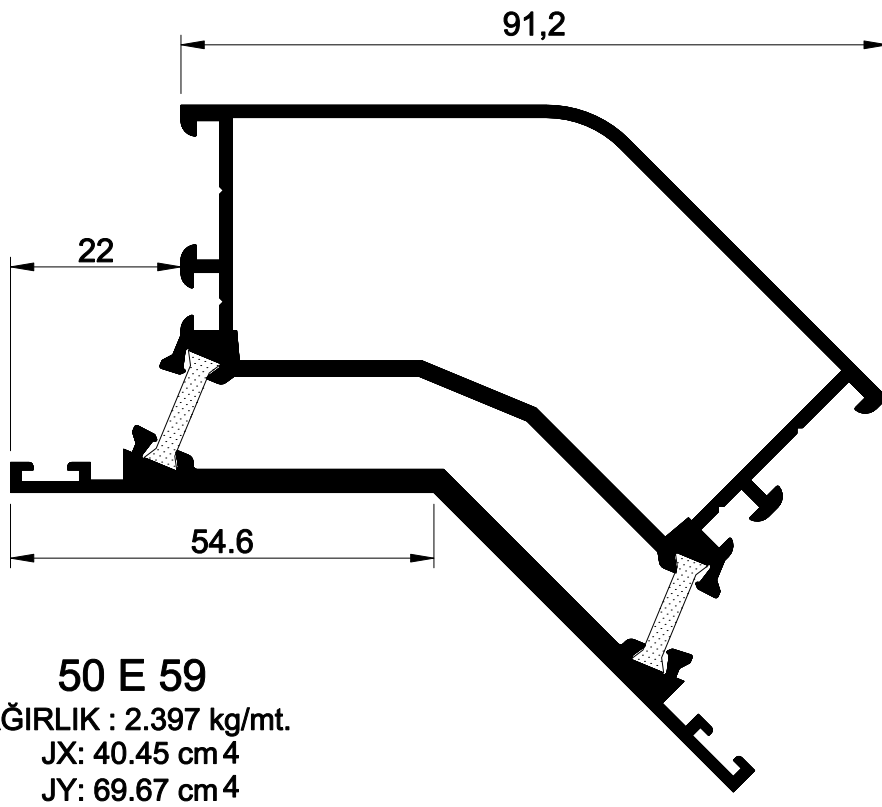
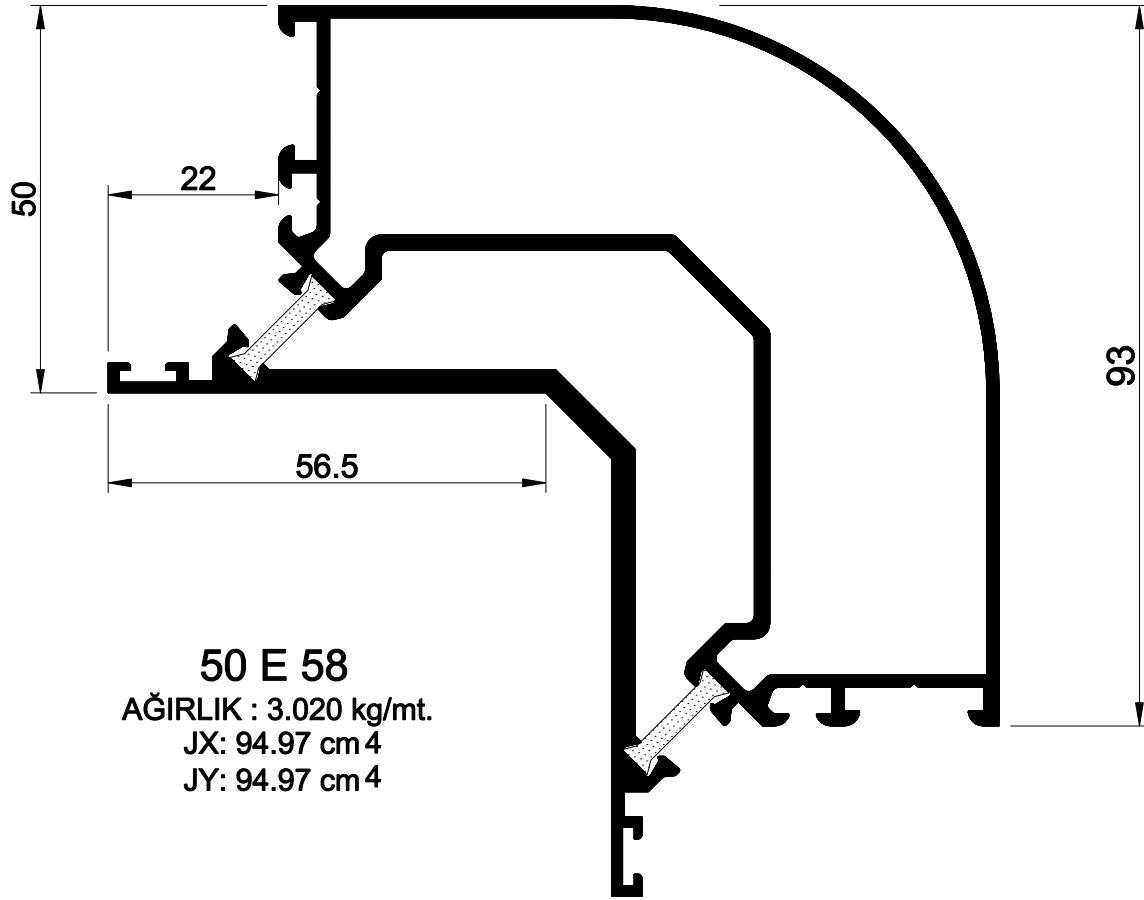

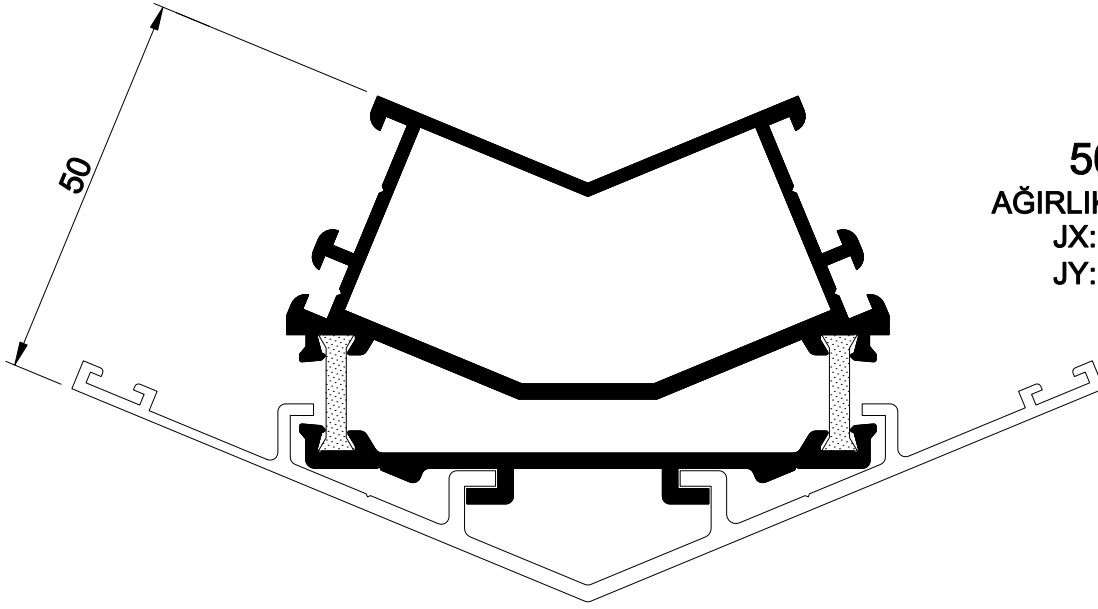

50 E 64
AĞIRLIK : 1.770 kg/mt.
JX: 15.75 cm⁴
JY: 37.15 cm⁴

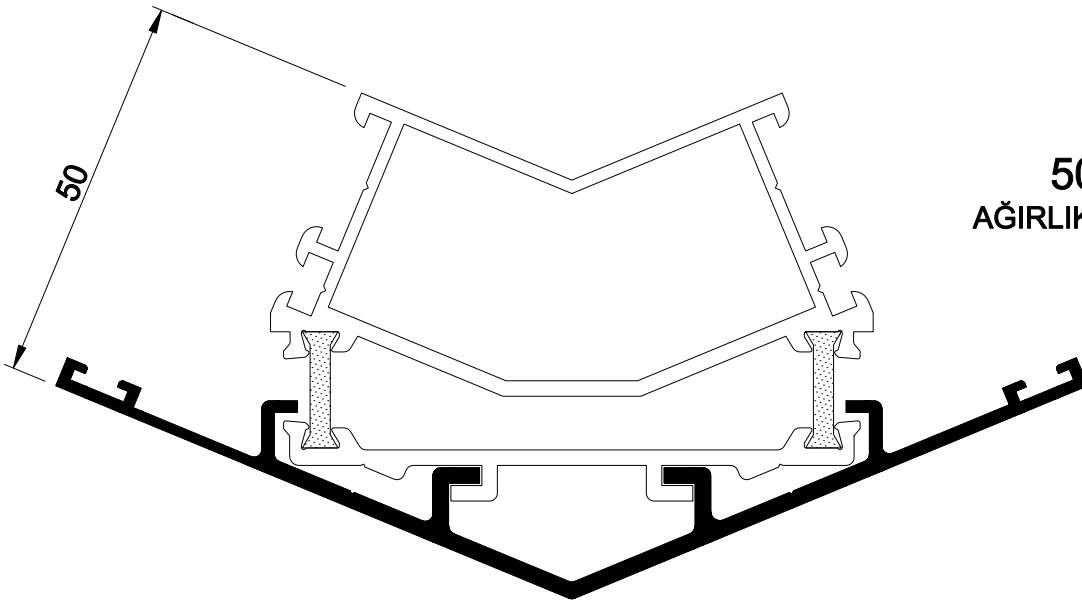

50 E 65
AĞIRLIK : 0.981 kg/mt.

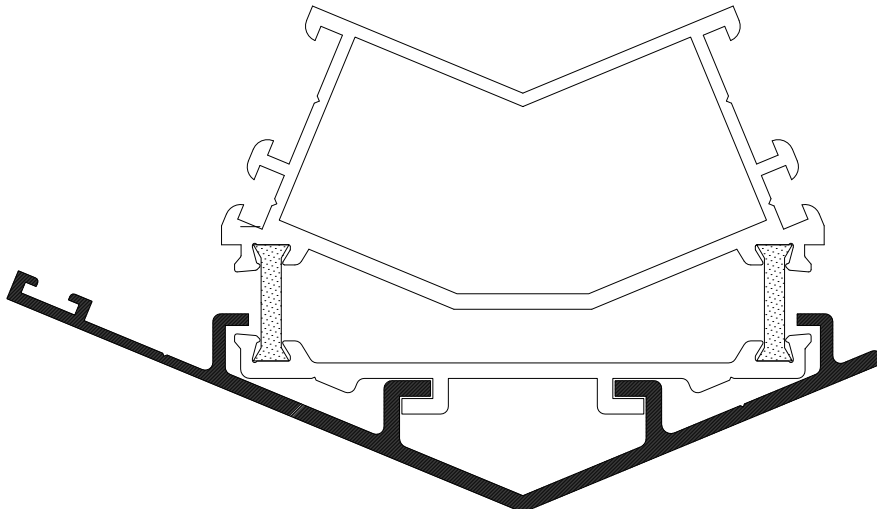

50 E 66
AĞIRLIK : 0.936 kg/mt.

DE 50 - SE 50

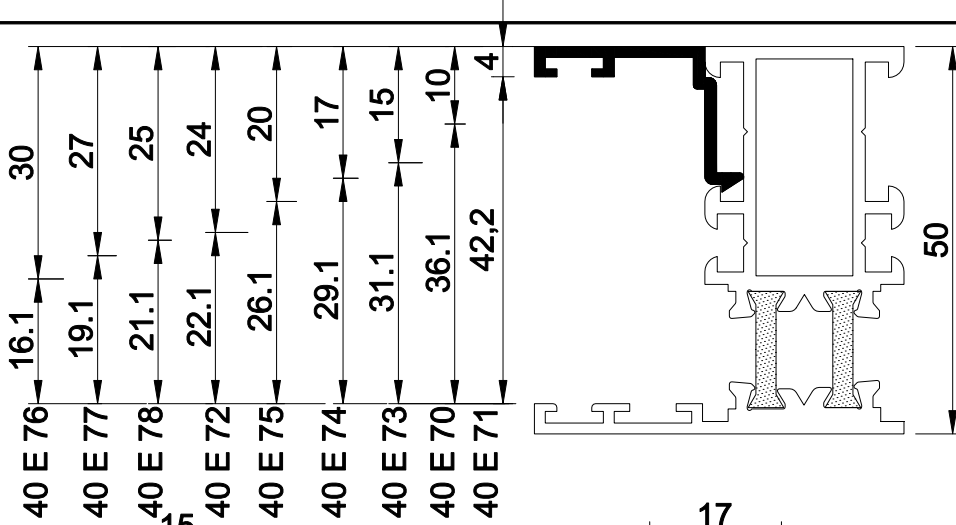

40 E 71

AĞIRLIK : 0.202 kg/mt.

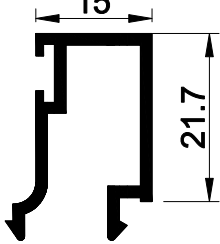

40 E 73

AĞIRLIK : 0.310 kg/mt.

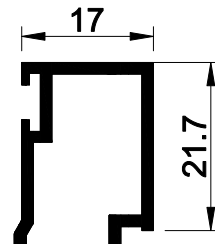

40 E 74

AĞIRLIK : 0.313 kg/mt.

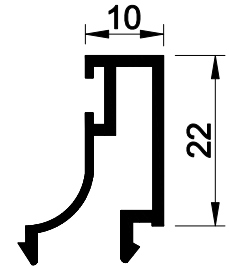

40 E 70

AĞIRLIK : 0.275 kg/mt.

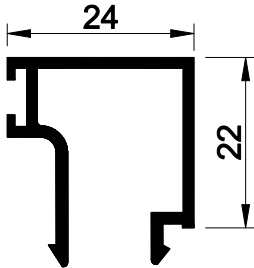

40 E 72

AĞIRLIK : 0.488 kg/mt.

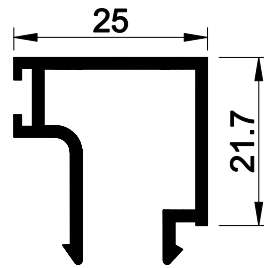

40 E 78

AĞIRLIK : 0.359 kg/mt.

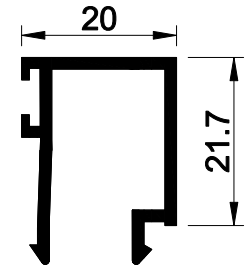

40 E 75

AĞIRLIK : 0.323 kg/mt.

Malzeme Kalınlığı	Çıta Profili	İç Cam Fıtlı	Dış Cam Fıtlı
9 mm	40 E 76	40 D 05 (4mm)	40 D 02 (3mm)
10 mm	40 E 76	40 D 03 (3mm)	40 D 02 (3mm)
12 mm	40 E 77	40 D 05 (4mm)	40 D 02 (3mm)
13 mm	40 E 77	40 D 03 (3mm)	40 D 02 (3mm)
14 mm	40 E 78	40 D 05 (4mm)	40 D 02 (3mm)
15 mm	40 E 72	40 D 05 (4mm)	40 D 02 (3mm)
16 mm	40 E 72	40 D 03 (3mm)	40 D 02 (3mm)
19 mm	40 E 75	40 D 05 (4mm)	40 D 02 (3mm)
20 mm	40 E 75	40 D 03 (3mm)	40 D 02 (3mm)
24 mm	40 E 73	40 D 05 (4mm)	40 D 02 (3mm)
25 mm	40 E 73	40 D 03 (3mm)	40 D 02 (3mm)
28 mm	40 E 70	40 D 05 (4mm)	40 D 02 (3mm)
29 mm - 30 mm	40 E 70	40 D 03 (3mm)	40 D 02 (3mm)
34 mm	40 E 71	40 D 05 (4mm)	40 D 02 (3mm)
35 mm	40 E 71	40 D 05 (4mm)	40 D 02 (3mm)
36 mm	40 E 71	40 D 03 (3mm)	40 D 02 (3mm)

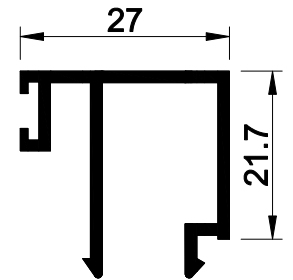

40 E 77

AĞIRLIK : 0.388 kg/mt.

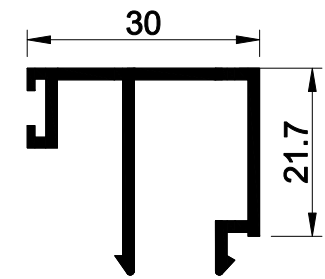

40 E 76

AĞIRLIK : 0.400 kg/mt.

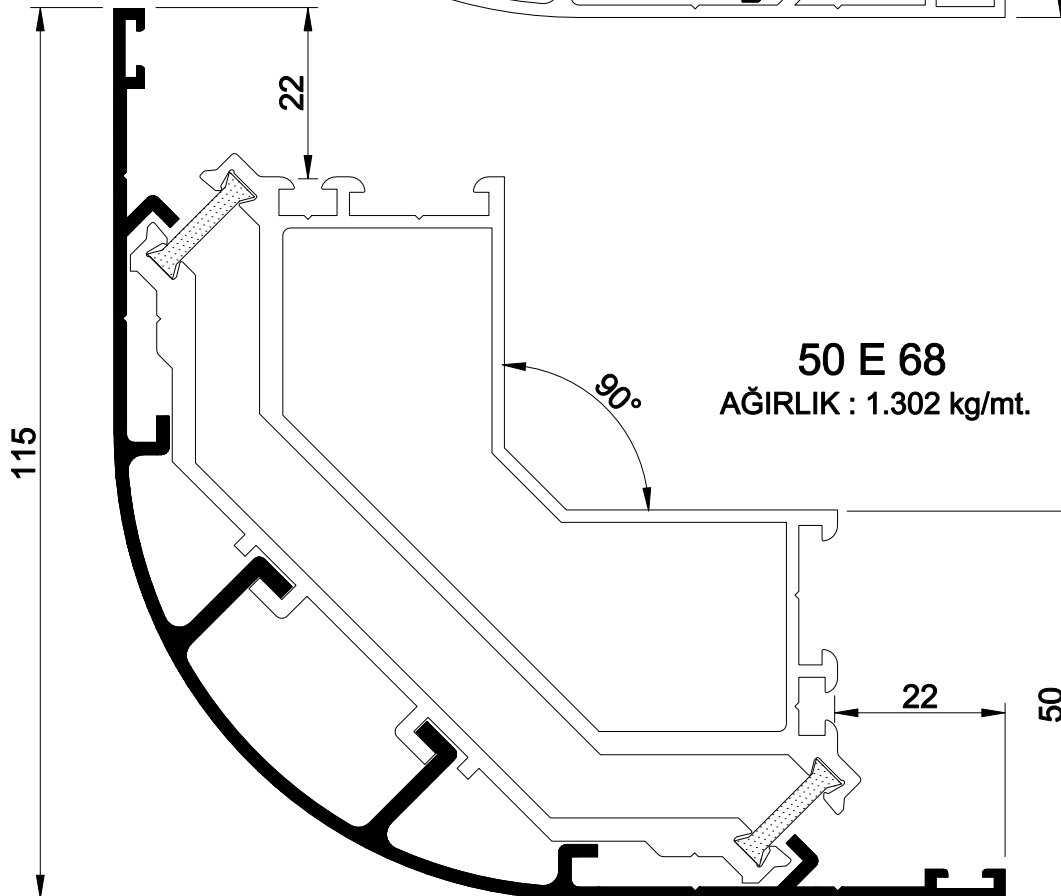
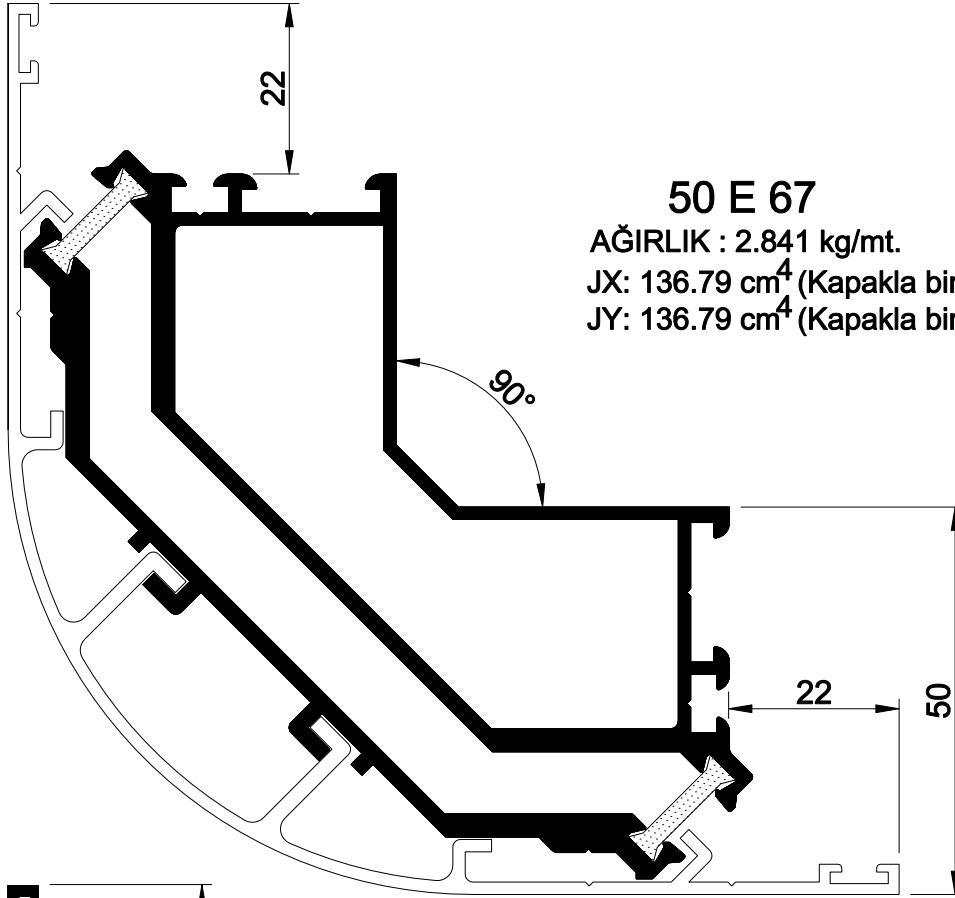

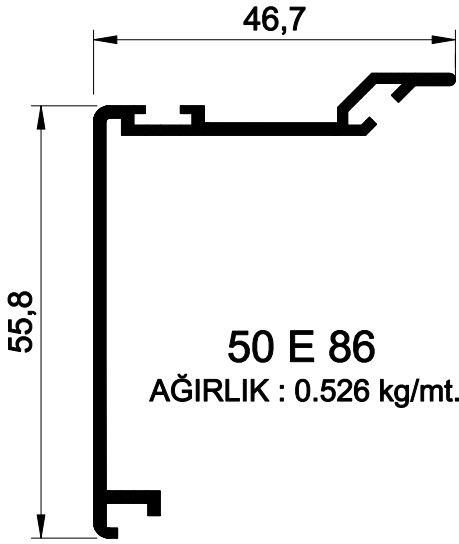

50 E 86
AĞIRLIK : 0.526 kg/mt.

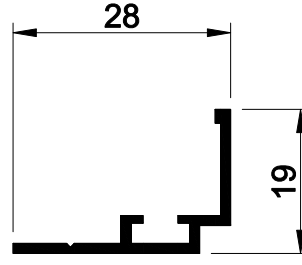

40 E 87
AĞIRLIK : 0.195 kg/mt.

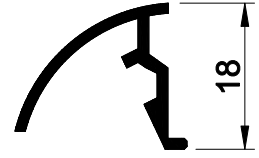

40 E 86
AĞIRLIK : 0.180 kg/mt.

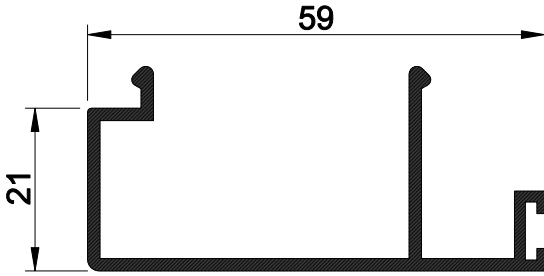

50 E 83
AĞIRLIK : 0.558 kg/mt.

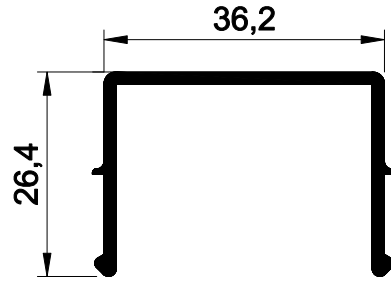

50 E 84
AĞIRLIK : 0.385 kg/mt.

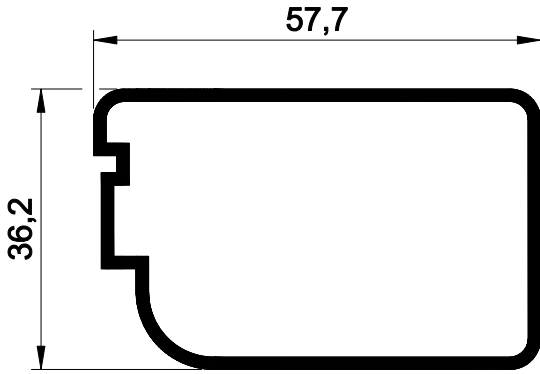

50 E 87
AĞIRLIK : 0.768 kg/mt.
JX: 5.82 cm⁴
JY: 12.15 cm⁴

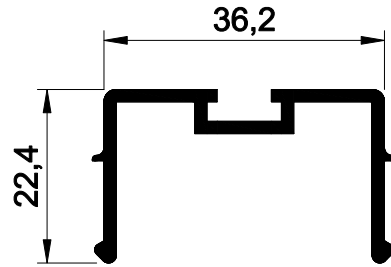

50 E 85
AĞIRLIK : 0.397 kg/mt.

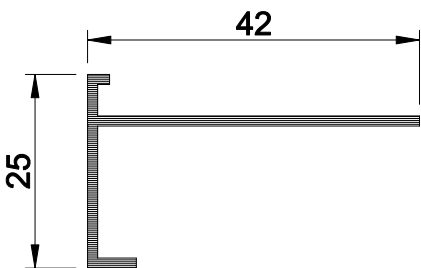

40 E 88
AĞIRLIK : 0.259 kg/mt.

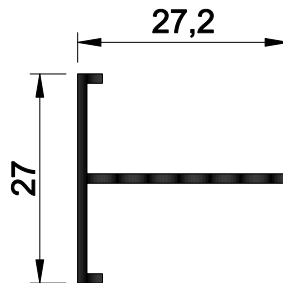

00-1322
AĞIRLIK : 0.185 kg/mt.

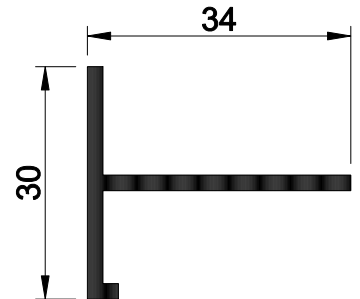

92-447
AĞIRLIK : 0.346 kg/mt.