

99-1044

AĞIRLIK : 1.703 kg/mt.
JX : 33.66 cm⁴
JY : 11.80 cm⁴

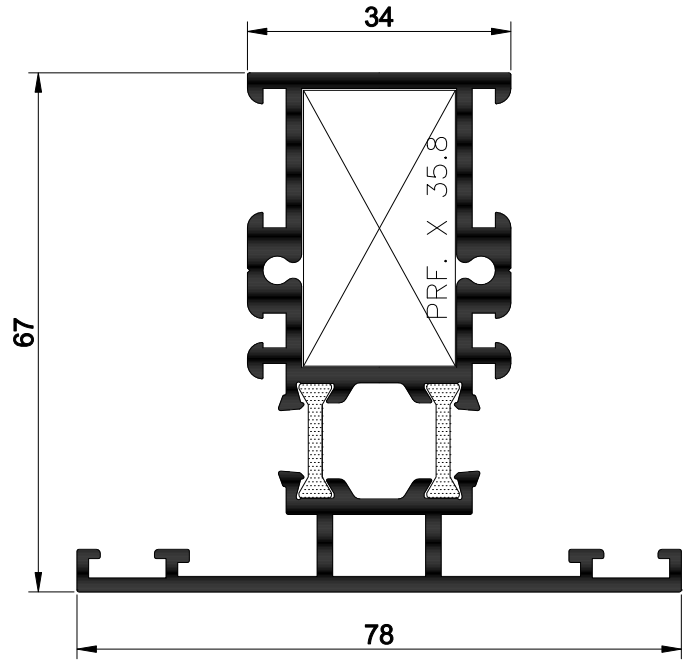

99-1046

AĞIRLIK : 1.995 kg/mt.
JX : 35.56 cm⁴
JY : 16.80 cm⁴

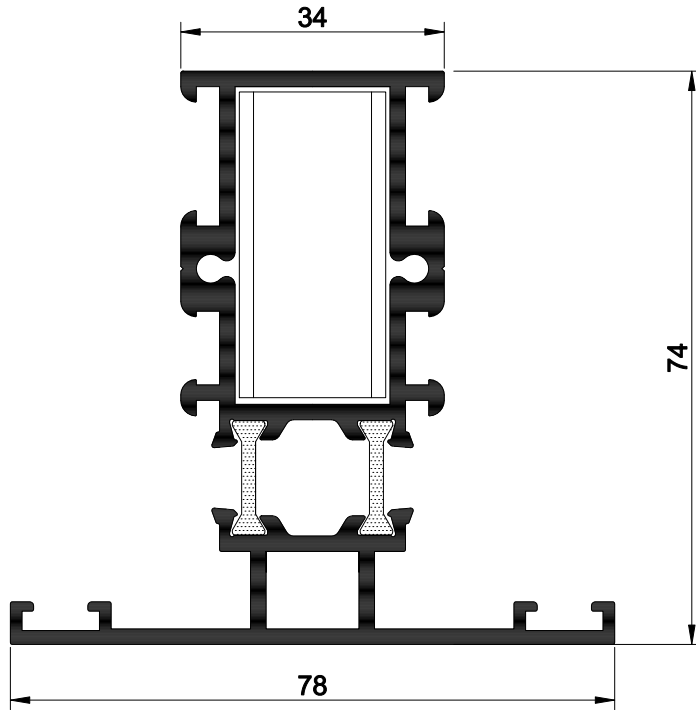

99-1050

AĞIRLIK : 2.144 kg/mt.
JX : 45.56 cm⁴
JY : 17.09 cm⁴

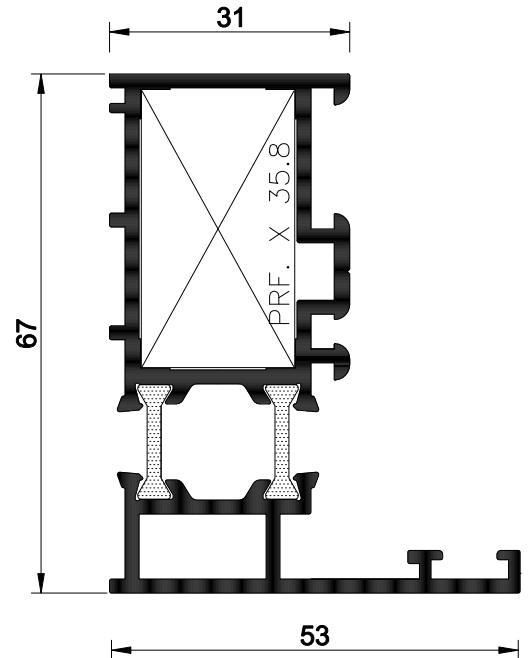

99-1158

AĞIRLIK : 1.526 kg/mt.
JX : 29.28 cm⁴
JY : 9.46 cm⁴

*** Kanat içi orta kayıt profili (99-1050)
99-1052 nolu profile kullanılmaz.

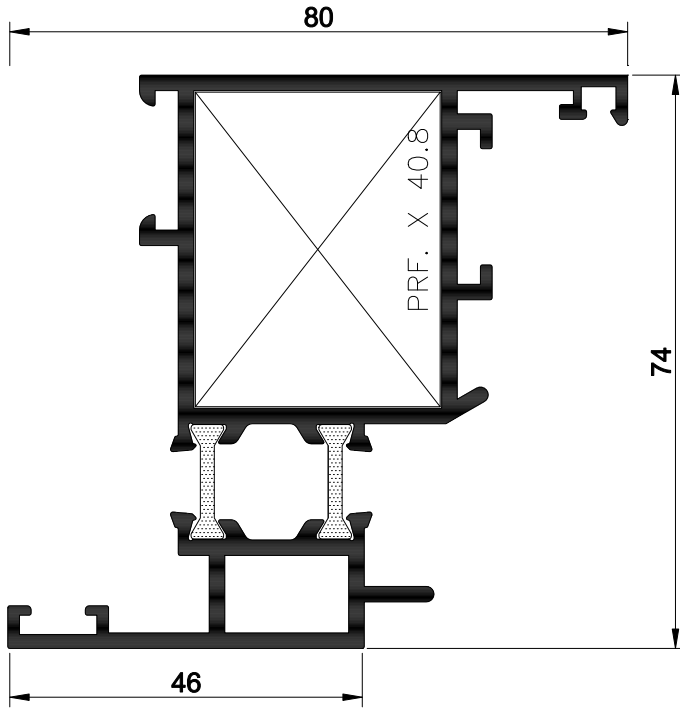

99-1048

AĞIRLIK : 1.958 kg/mt.
JX : 48.59 cm⁴
JY : 21.70 cm⁴

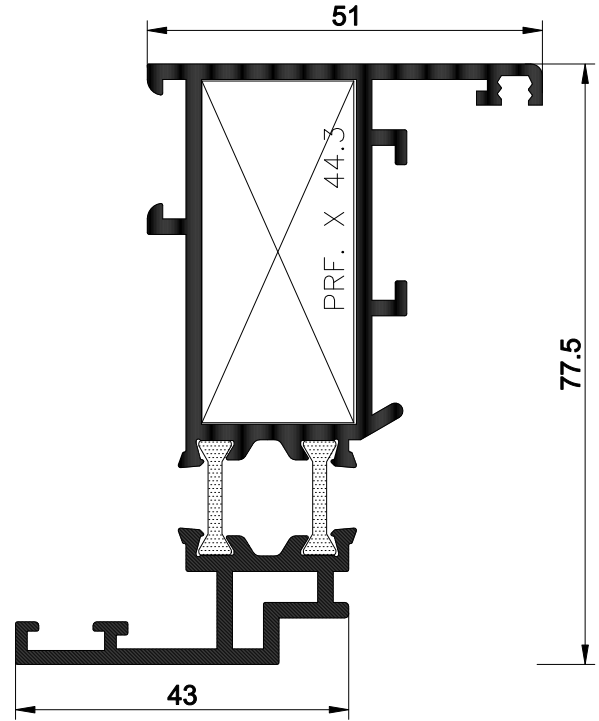

99-1052

AĞIRLIK : 1.786 kg/mt.
JX : 47.33 cm⁴
JY : 11.92 cm⁴

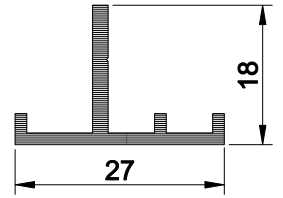

98-967

AĞIRLIK : 0.227 kg/mt.

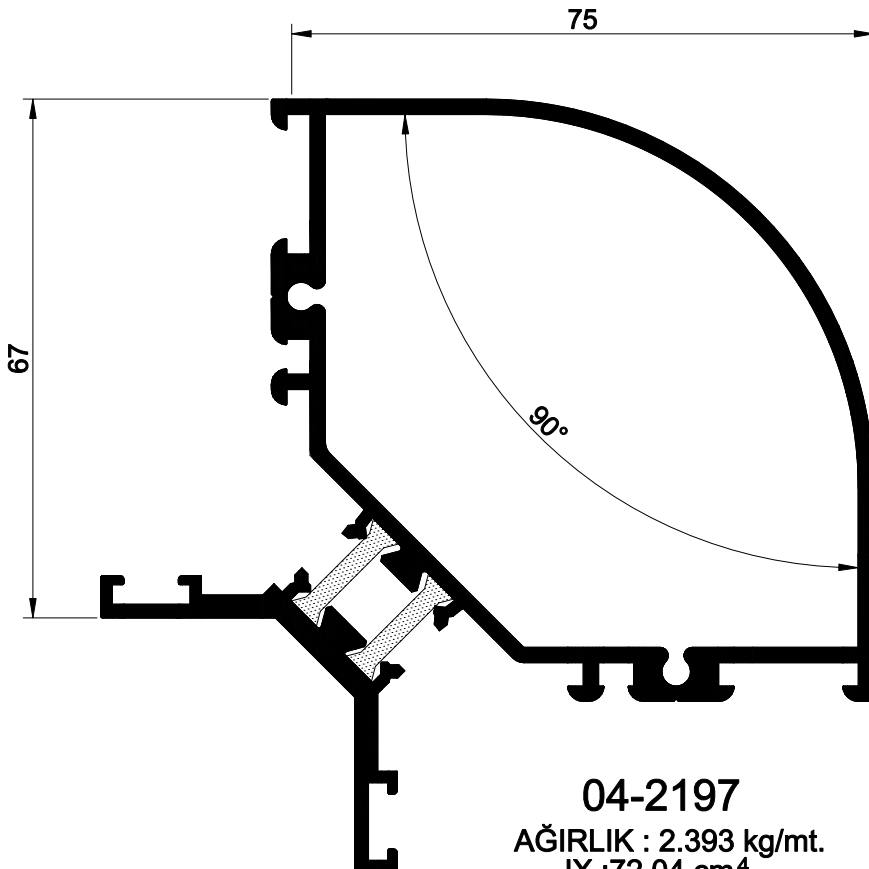

04-2197

AĞIRLIK : 2.393 kg/mt.
JX : 72.04 cm⁴
JY : 75.21 cm⁴

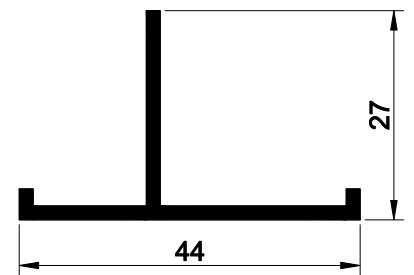

05-2352

AĞIRLIK : 0.359 kg/mt.



88-033

AĞIRLIK : 0.140 kg/mt.

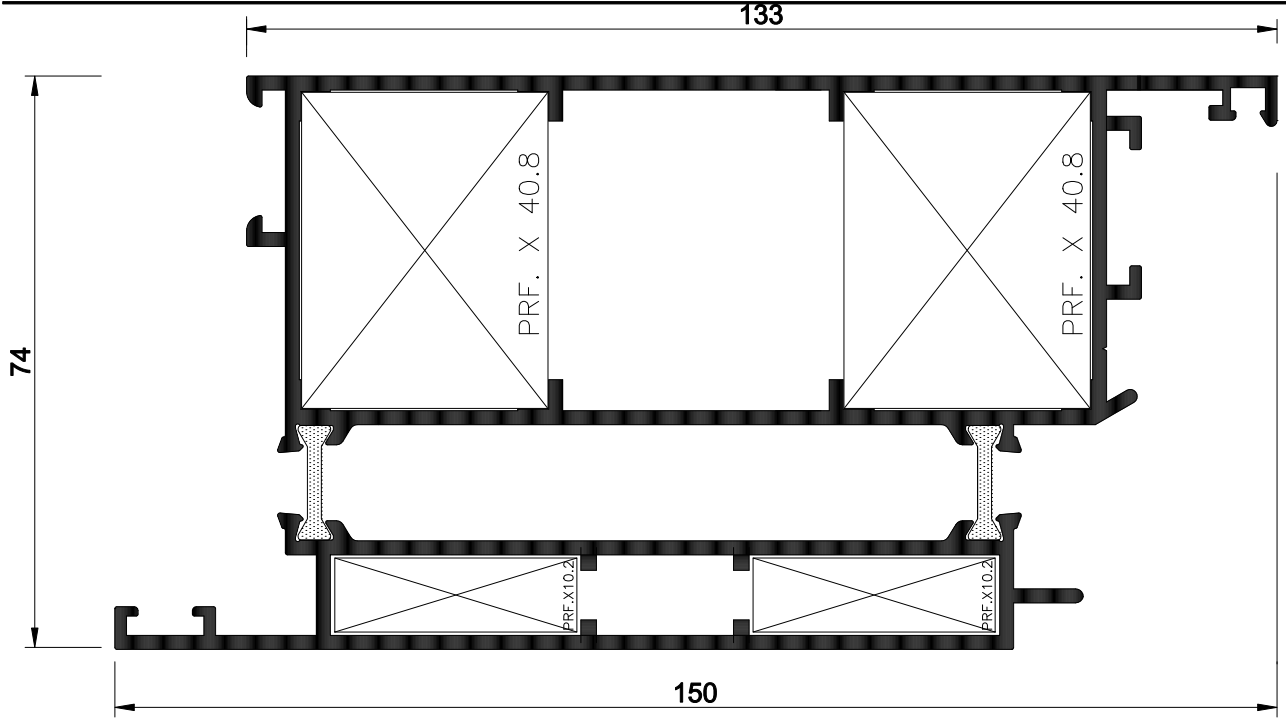

99-1162

AĞIRLIK : 3.302 kg/mt.
JX : 94.42 cm⁴
JY : 204.32 cm⁴

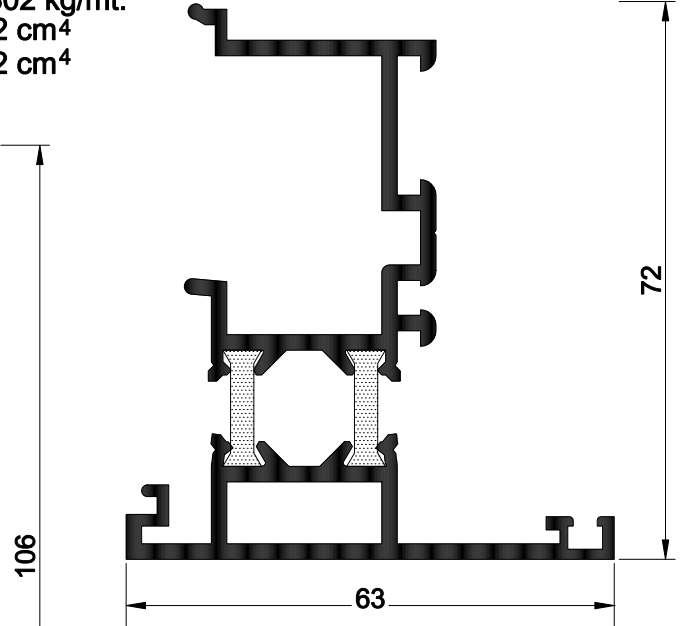
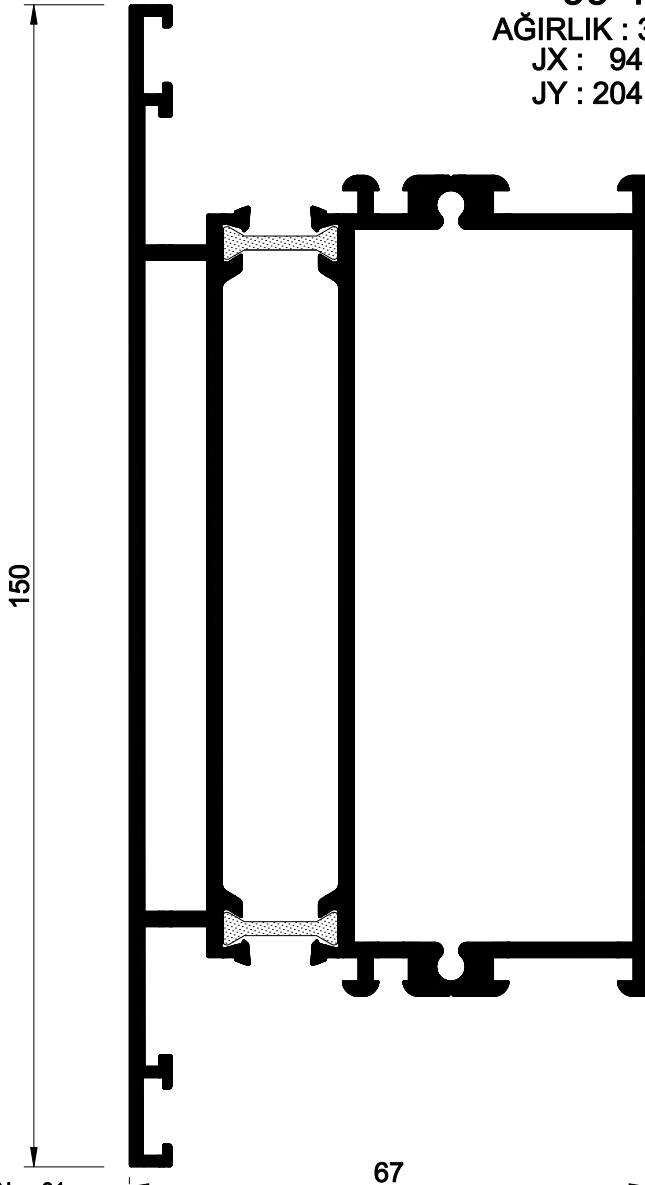

94-669

AĞIRLIK : 1.528 kg/mt.
JX : 28.48 cm⁴
JY : 10.17 cm⁴

*** Sabit doğramalarda etek profili olarak kullanılıyor.

02-1723

AĞIRLIK : 3.422 kg/mt.
JX : 199.60 cm⁴
JY : 71.20 cm⁴

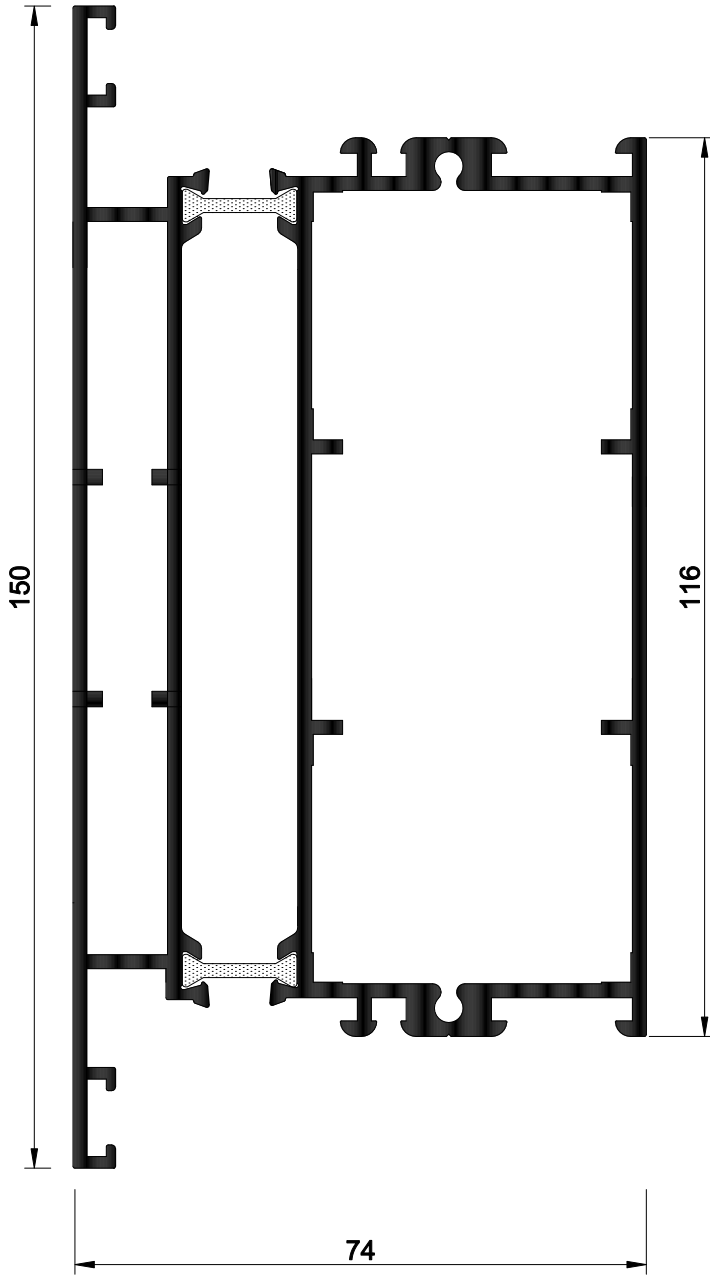

*** Kanatta etek profili ve orta kayıt profili olarak kullanılıyor.

99-1160

AĞIRLIK : 3.593 kg/mt.

JX : 230.00 cm⁴

JY : 88.40 cm⁴

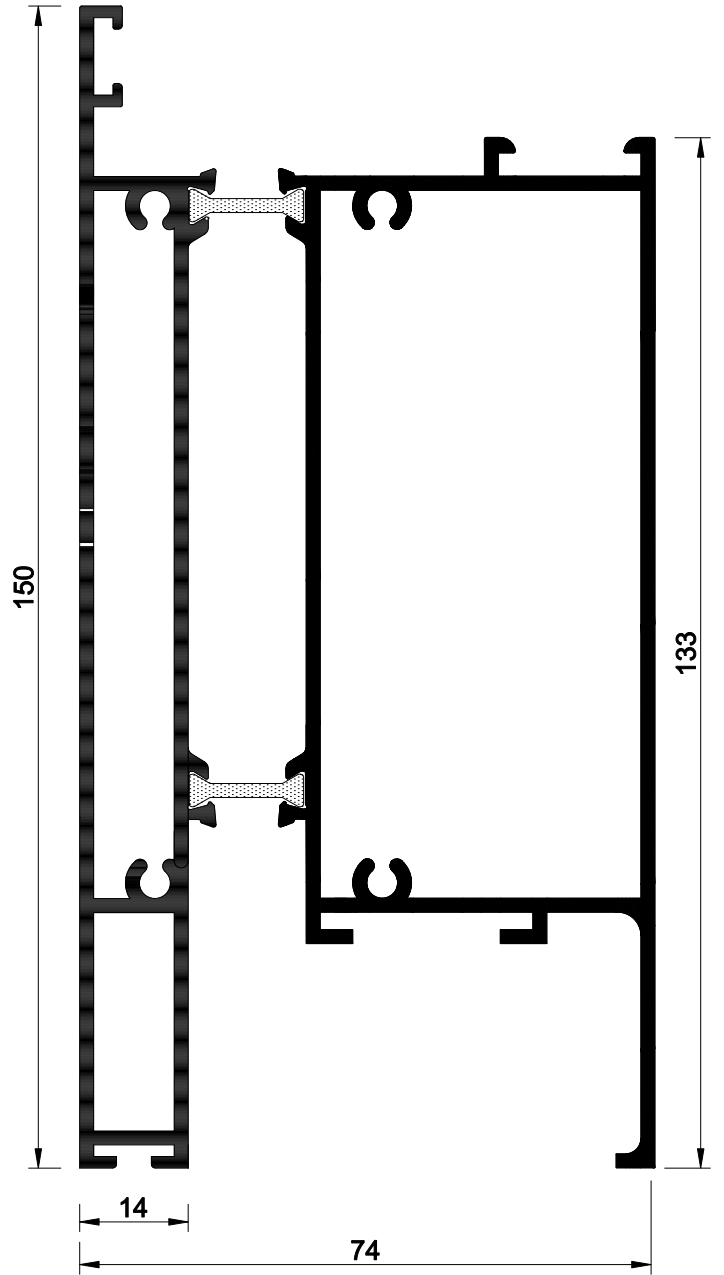

*** Kanatta etek profili olarak kullanılıyor.

99-1164

AĞIRLIK : 3.723 kg/mt.

JX : 311.62 cm⁴

JY : 104.51 cm⁴

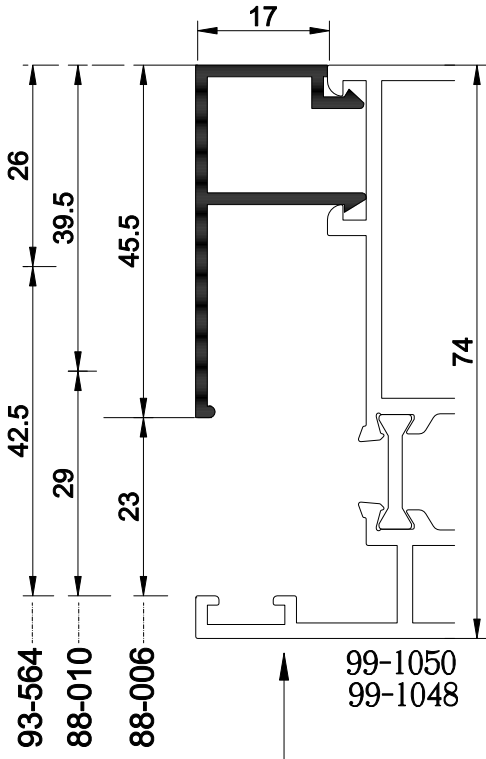

*** Kanat içi orta kayıt profili (99-1050)

